



# Solid Modeling



<http://hm.softalliance.net/>

*Alexander Pasko, Evgenii Maltsev*



# Contents

## 1. Characterization of representation schemes for solids

- “Abstract solid”
- Definitions
- Formal properties of representations
- Informal properties

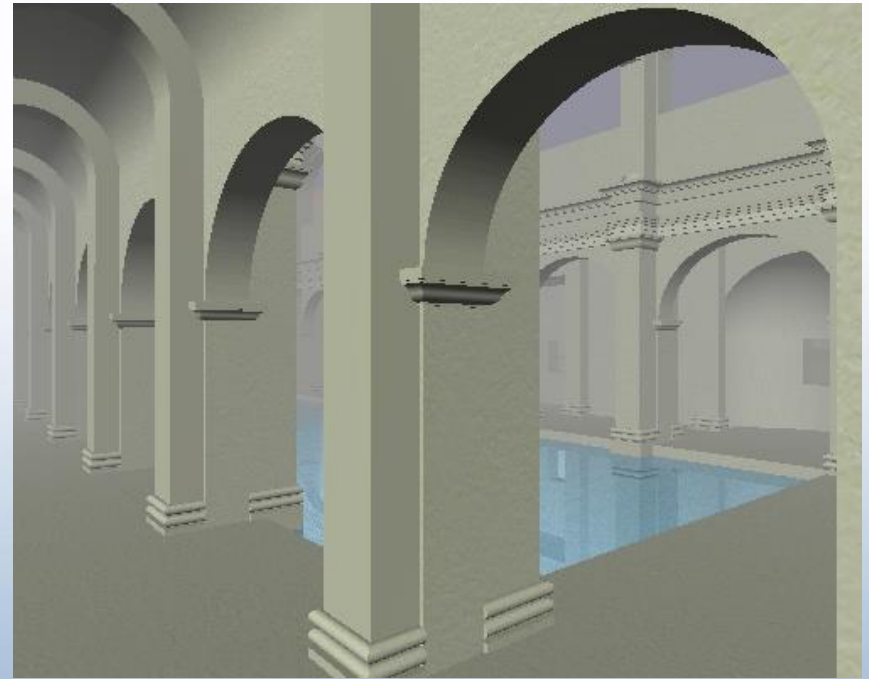

**The svLis model of the Great Bath in  
in Aquae Sulis as it was in 200 AD**



# Contents

## 2. Schemes for representing solids

- Ambiguous schemes
- Pure primitive instancing
- Cell decompositions
- Spatial occupancy enumeration
- Constructive Solid Geometry
- Sweep representations
- Boundary representations
- Medial Axis Transforms



*"Still with Bolts"* by [Jaime Vives Piqueres](#) (2002)



# Contents

- Ray representations
- Parametric function representations
- Real function representations
- Hybrid schemes and conversions

## 3. Solid modelling systems

## 4. References

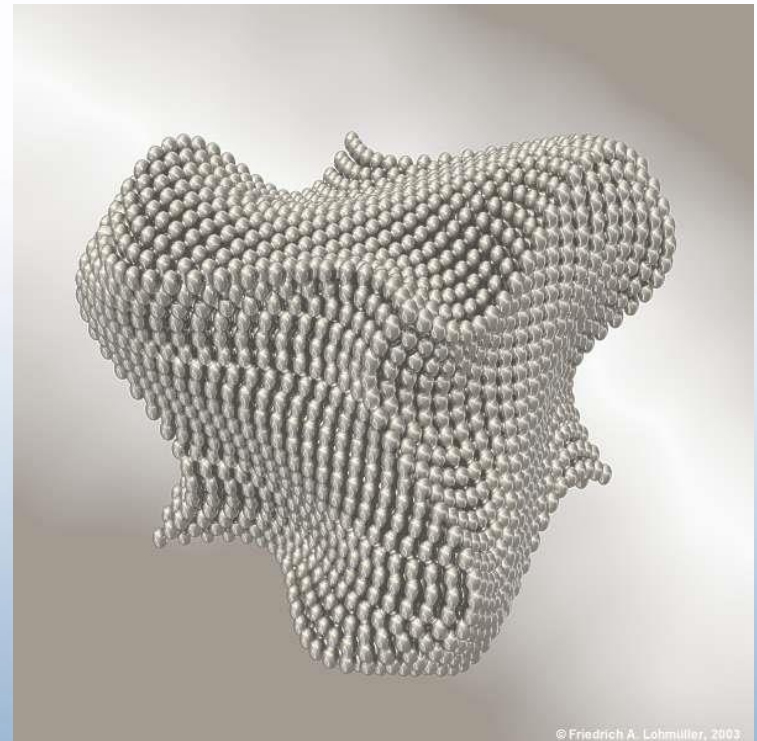

*"Dancing Cube"* by [Friedrich A. Lohmueller](#) (2003)

A historical summary of approaches to 3-D object representation

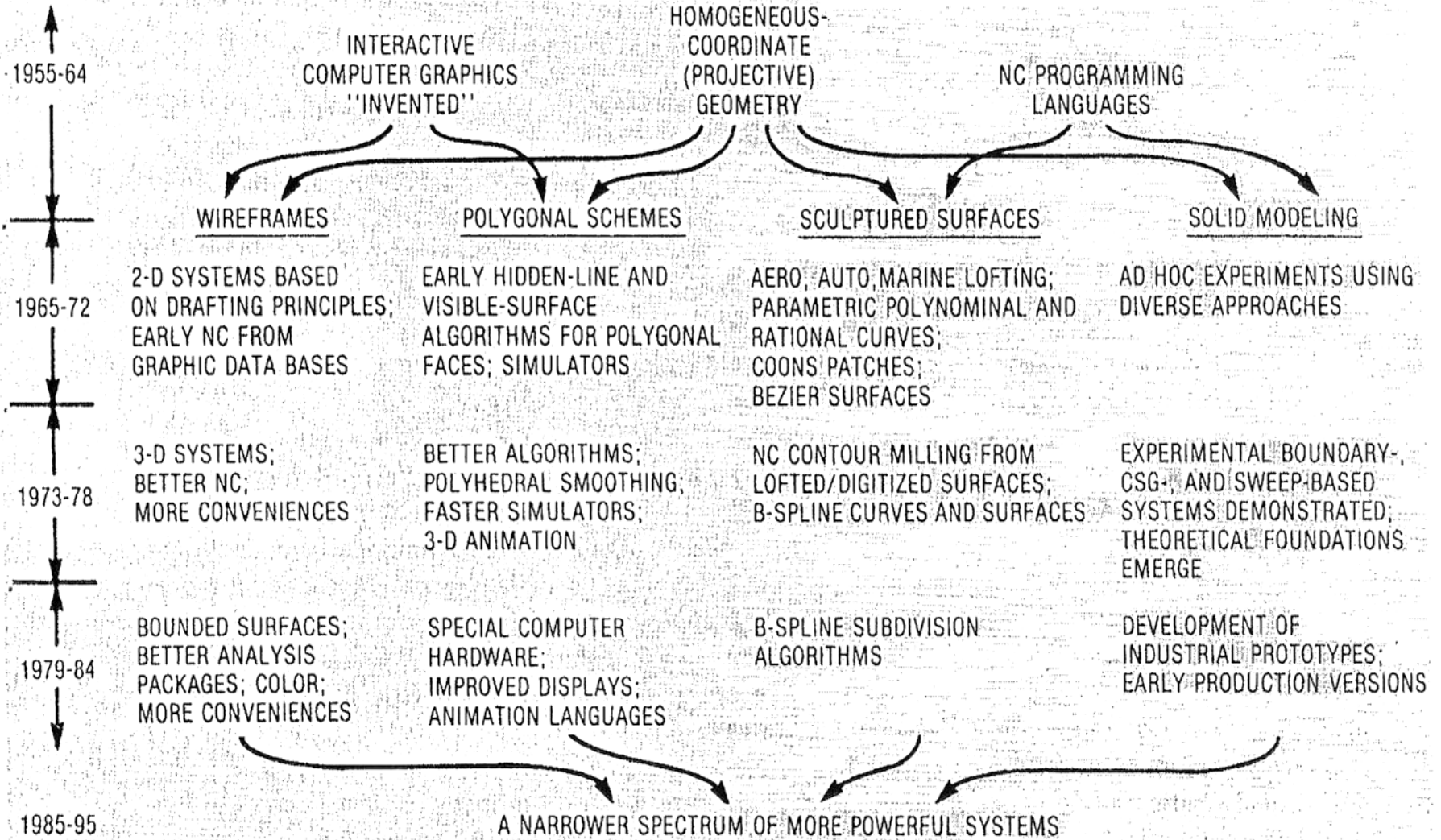



# Solid Modelling System

---

A **solid modelling system** has four primary components [Requicha, 1980]:

- Symbol structures which represent solid objects;
- Processes which answer geometric questions (such as “What is the volume?”) using the symbol structures;
- Input facilities for creating and editing object representation;
- Output facilities and representations of result.

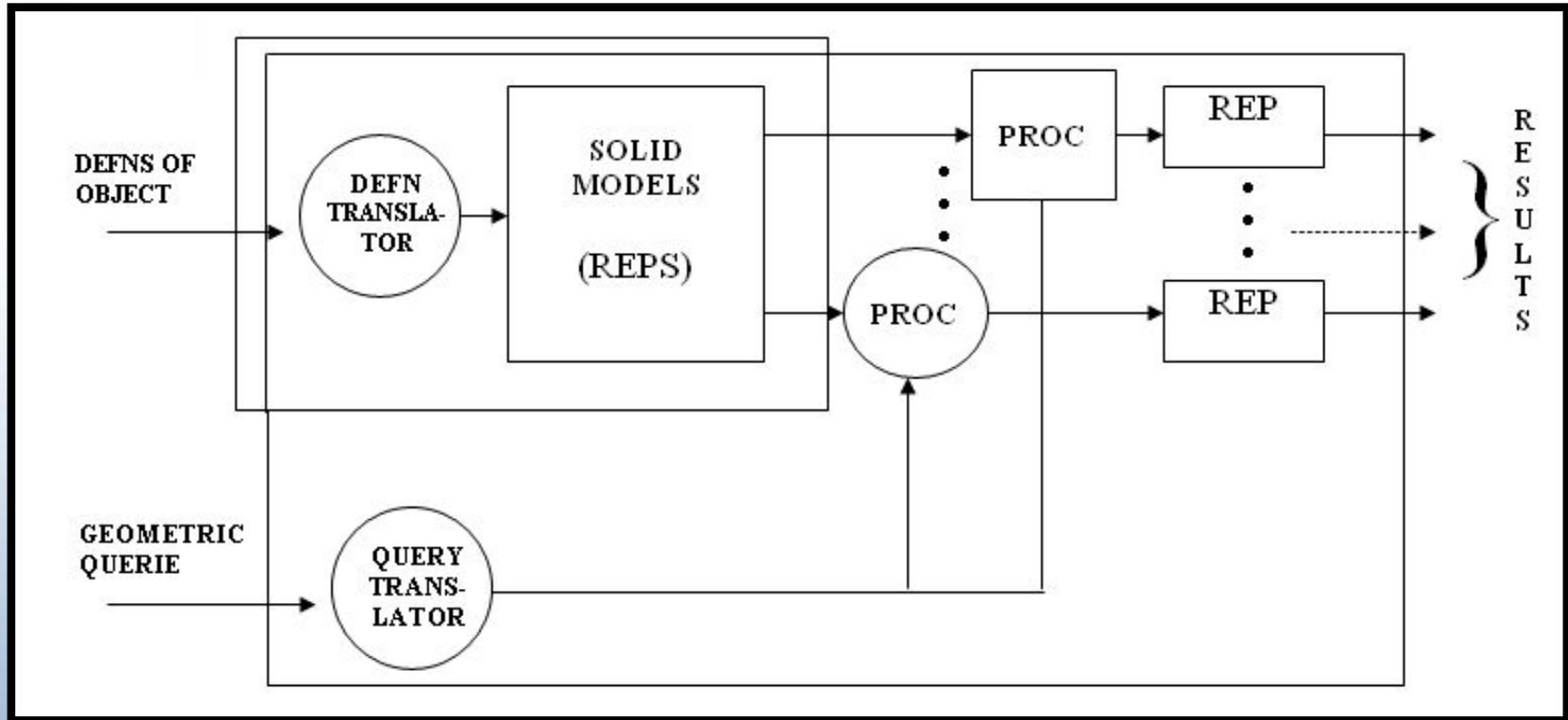

Requicha, Comp. Surveys, p.438

**Solid modelling system** is a subsystem which provides entering, storing and modifying object representation.



# Abstract solid

---

Properties that should be captured by the notion of “abstract solid”:

- **Rigidity:** An abstract solid must have an invariant shape which is independent of the solid’s location and orientation.
- **Homogeneous three dimensionality:** A solid must have an interior, and a solid’s boundary cannot have isolated or dangling portions.
- **Finiteness:** A solid must occupy a finite portion of space.





- **Closure:** Rigid motions (translations and rotations) or operations that add or remove material (set-theoretic operations) must produce another solid.
- **Finite describability:** There must be some finite aspect of 3D models of solids (a finite number of “faces”) to make them representable in computers.
- **Boundary determinism:** The boundary of a solid must determine unambiguously what is “inside” the solid.



# Representation scheme

A **representation scheme** establishes a correspondence between  $M$  and  $R$ .

It is defined as relation

$$s: M \rightarrow R$$

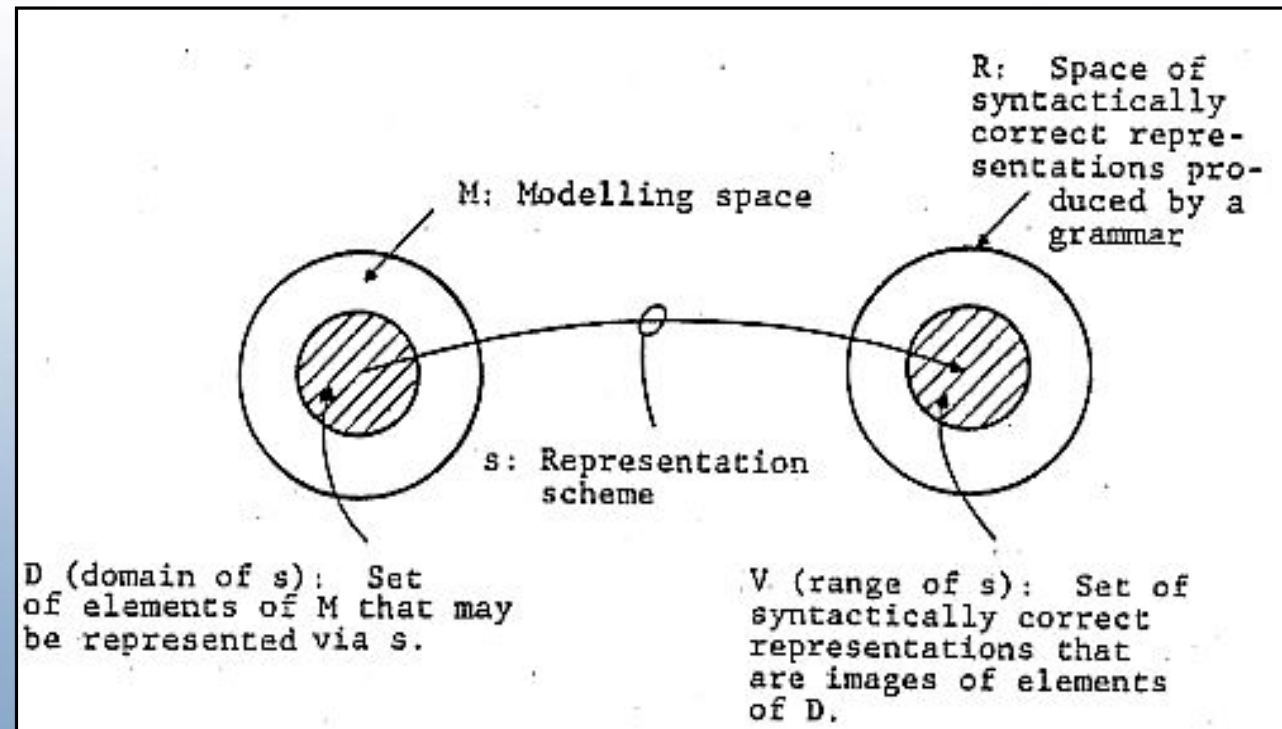



# Abstract solid : r-sets

---

Suitable models for solids are **r-sets** that are bounded, closed, regular, and semi analytic subsets of 3D Euclidean space ( $E^3$ ).

- A **bounded set**

occupies a finite portion of space.

- **Closed set**

The set is **closed** if it contains its boundary.



## - Regular

It is a **closed** set. It contains its boundary.

It is **not** a **regular** set because its boundary has dangling portions that are not adjacent to the set's interior.

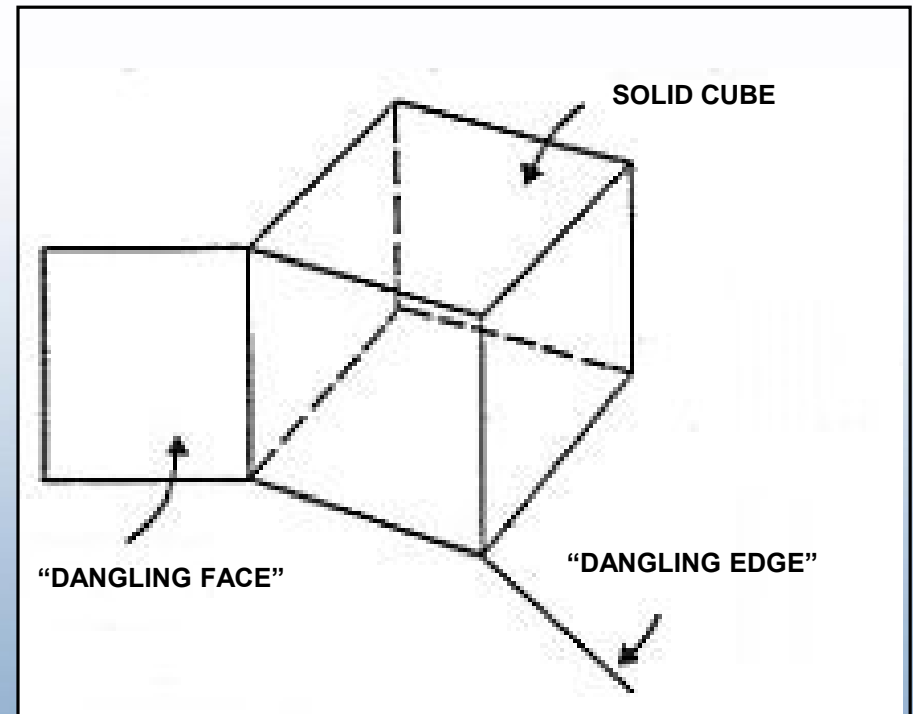



## - Semi-analytic set

This set is **not semi-analytic** because its top face is ill-behaved; it oscillates infinitely as it approaches the left face.

EXPANDED VIEW OF NEIGHBORHOOD  
SHOWING ALTERNATING SLICES OF “AIR”  
AND “MATERIAL”

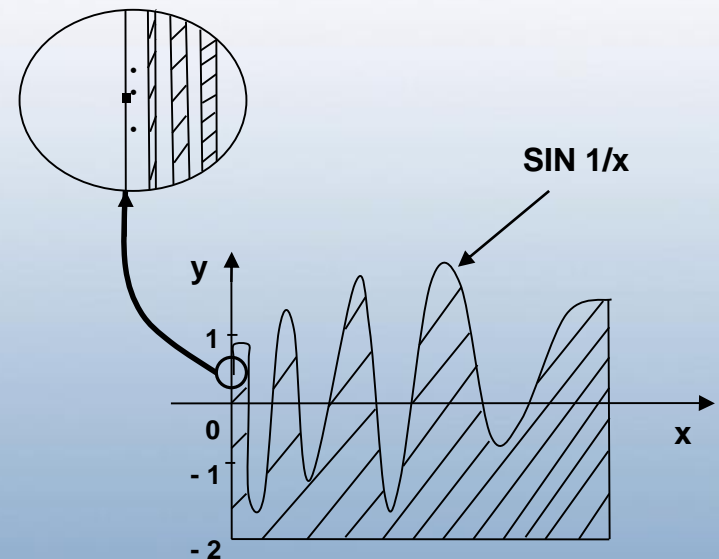



# Representation scheme

---

Syntactically correct representations are finite symbol structures constructed according to syntactical rules.

- The collection of all syntactically correct representations is called a **representation space  $R$** .
- Abstract solids (r-sets) are the elements of a **mathematical modelling space  $M$** .



# Formal properties of representations

---

- **Domain**

The domain is the set of solids representable in the representation scheme (its descriptive power).

- **Validity**

A symbol structure, which corresponds to a nonsense object, should not exist.



# Formal properties of representations

## Unambiguous representation

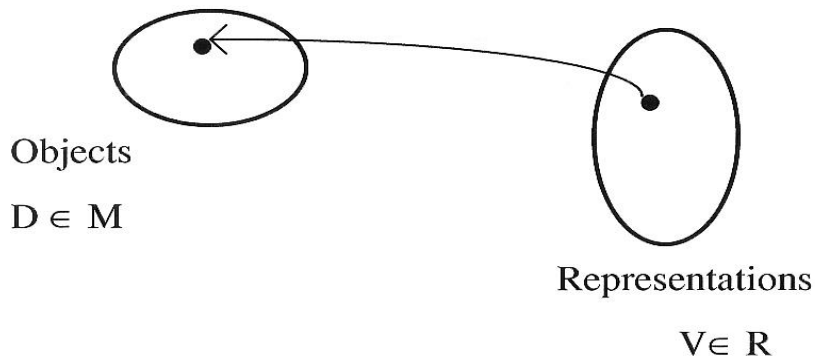

## Ambiguous

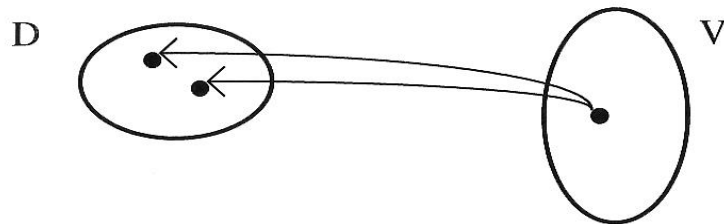

- Completeness (non-ambiguity)

A representation  $r \in V$  is unambiguous if it corresponds to a single object in  $D$ . A scheme is complete or unambiguous if all of its valid representations are unambiguous.





- **Uniqueness.** A scheme is unique if for one object there is one and only one representation.

Representational schemes which are both unambiguous (complete) and unique are highly desirable because they are one-to-one mappings.

Unique representation

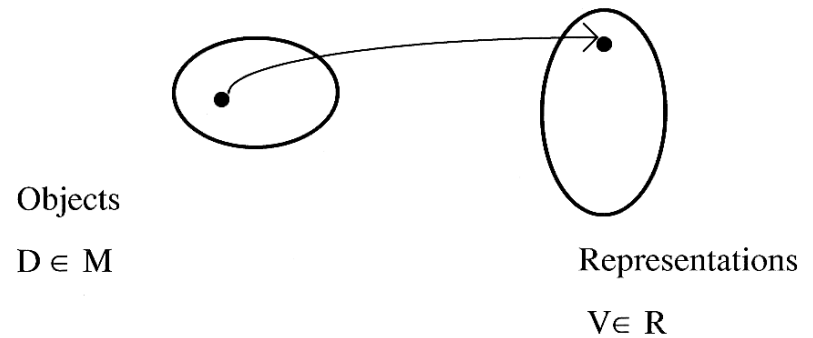

Nonunique representation

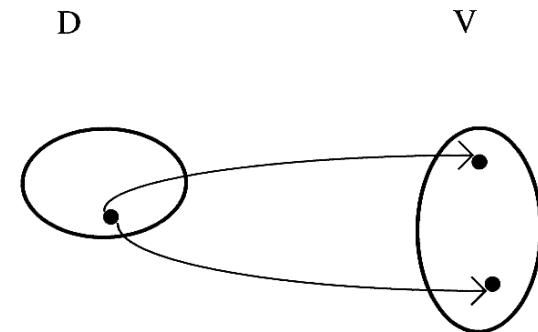



# Informal properties of representation schemes

---

- **Conciseness.**

This refers to the “size” of representations in a scheme (proportional to required memory).  
Compare: equation and polygonal model.

- **Ease of creation.**

Concise representations generally are easier to create. Input subsystems are needed to help users to create representations.



- Suitability for applications.

Example: Roman numbers are not convenient for arithmetic operations. In solid modelling, no single representation is uniformly “best”.

Multiple representations are suitable for general-purpose solid modelling systems.



# Ambiguous schemes

---

## 1) Engineering drawings (drafts).

No formal definition as a representation scheme.

More formal corresponding schemes:

- Collections of **planar projections**.  
Mapping to a 3 solid is needed.



- Suitable collections of 3D entities. Selection of “edges” leads to wire frame representations.

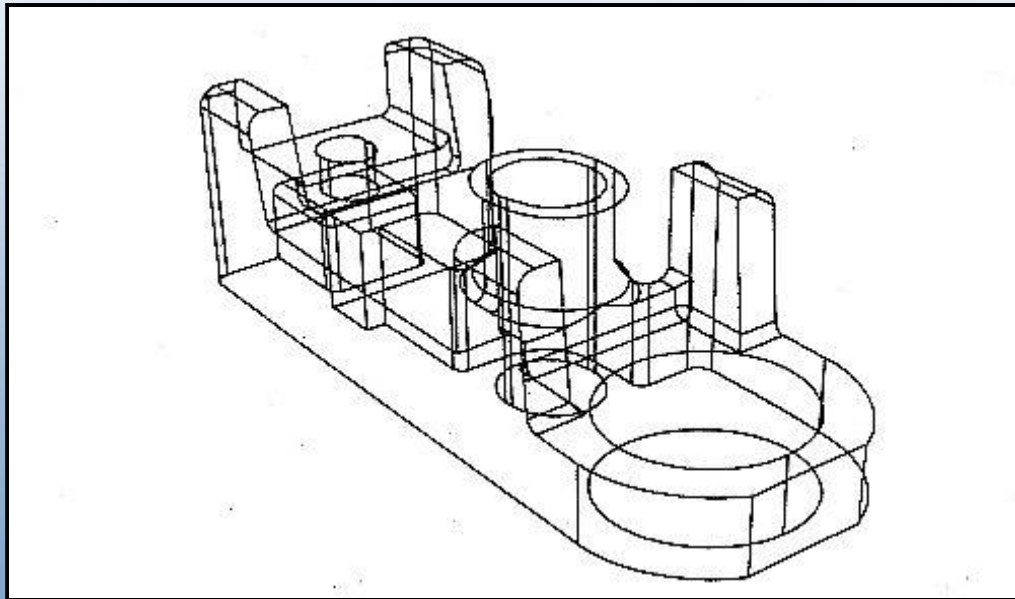



## 2) Measurements of physical solids.

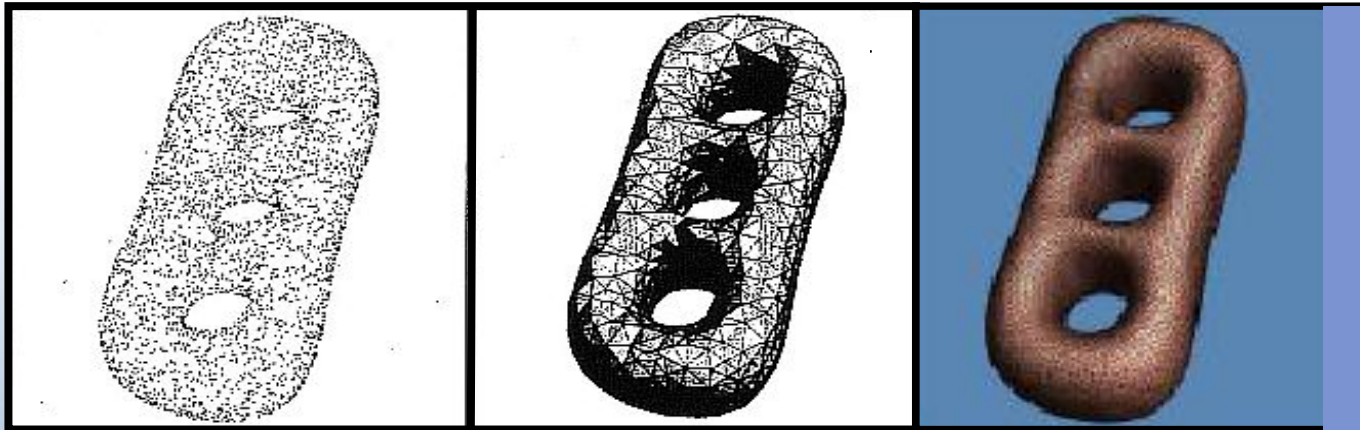

(a) Input:  
4000 unorganized points  $P$

(b) Step 1:  
Reconstructed mesh  $M$

(c) Step 2: Smoothed mesh

A solid is represented by a set of coordinates of points lying on the boundary or inside the object.



# Pure Primitive Instancing

The modelling system defines a set of primitive 3D solid shapes for the specific application area:

**primitive<sub>i</sub> (a<sub>1</sub>, a<sub>2</sub>, ..., a<sub>k</sub>)**

- Primitive with parameters define a family of parts;
- Primitives may include complex objects (gears, bolts, etc.);

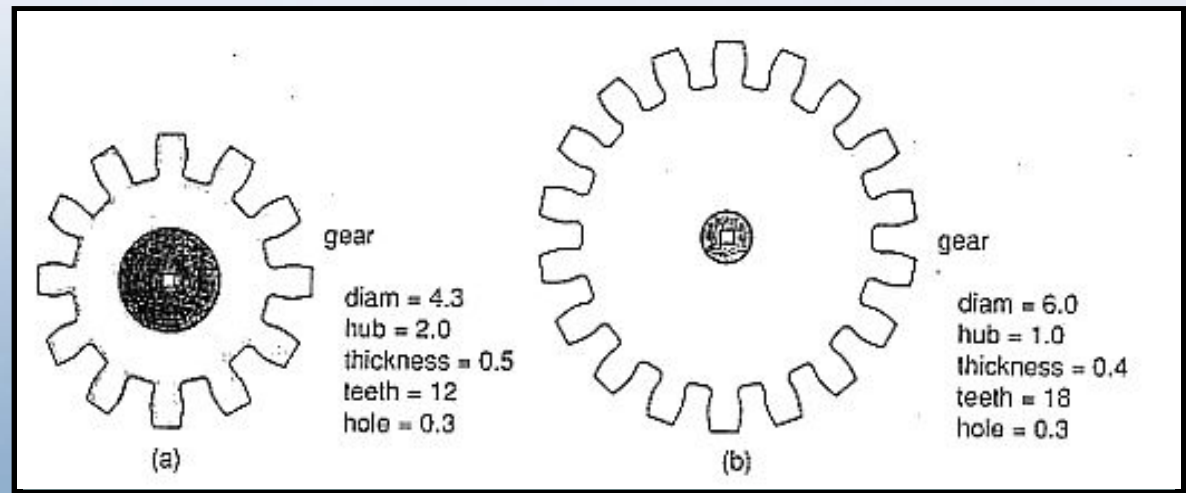

Two gears defined by primitive instancing.



- No operations to form a new more complex object;
- Only one way to create a new kind of object - to write the code that defines it;
- Programs to draw or to calculate mass properties must be written individually for every primitive.





# Pure primitive instancing

---

## Properties:

- Unambiguous.

A set of parameters defines one solid.

- Unique.

For a solid only one set of parameters exists.

- Concise and easy to validate.



# Properties

---

- Easy to use.
- **Domains** are small enough to be covered by a small catalog of primitives with small number of parameters.
- **Efficient** in specific applications but allow no uniform treatment.



# Cell decompositions

---

- Parameterized set of primitive cells that are often curved
- Constructing complex object by “gluing” primitive cells together
- Restrictions on the “glue” operation often require that two cells share a single point, edge, or face



- Representation is not unique:

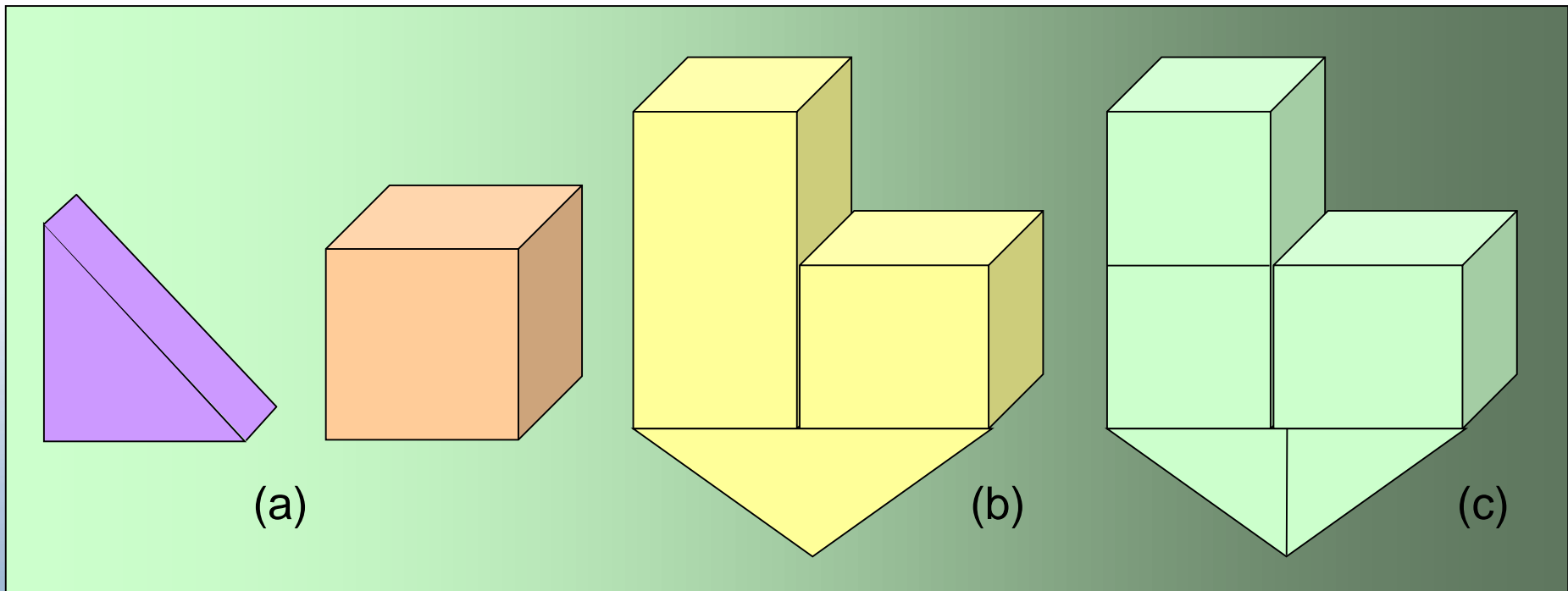

The cell shown in (a) may be transformed to construct the same object shown in (b) and (c) in different ways.



## Properties

---

- Unambiguous

A set of cells defines one solid

- Validity

is computationally expensive to establish

- Not concise

- Not easy to create



- **Convenient**

for computing topological properties:

- “one-piece” detection (connectivity)
- check “voids” or “holes”

Cell decomposition is used in 3D finite element methods (FEM) for the numerical solutions of differential equations.



# Spatial occupancy enumeration

- Special case of cell decomposition with **identical cells** arranged in a **fixed, regular grid**
- The cells are often called **voxels**
- The most common cell type is the **cube**, and the representation of space as a regular array of cubes is called a **voxel array** (a cuberrile)

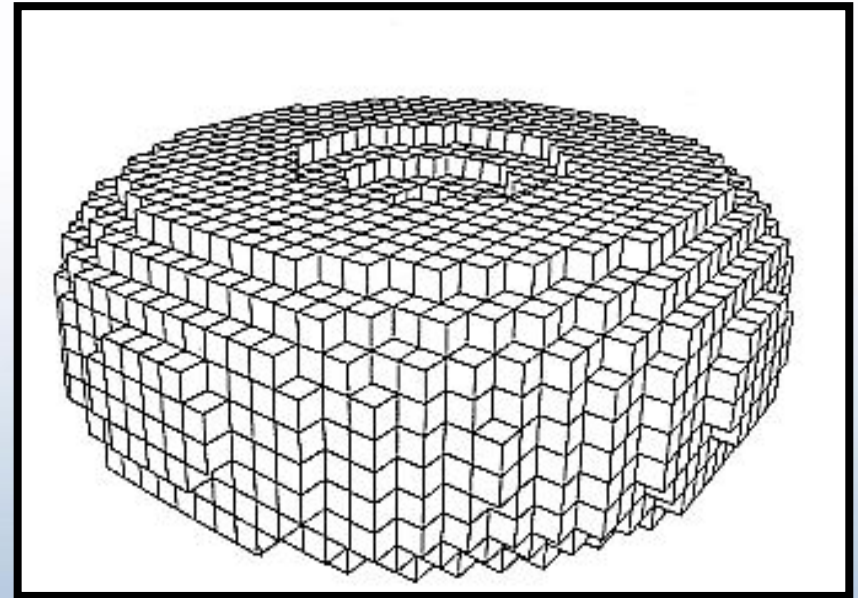

Torus represented by spatial-occupancy enumeration.



- For every cell, only its presence or absence in the grid is defined
- A cell is presented in the grid if it is occupied by the object
- Disadvantages:
  - approximate model, no concept of “partial occupancy”
  - memory consuming (up to  $n^3$  cells)





# Properties

---

- Unambiguous.

A set of voxels defines one solid.

- Unique.

For a solid only one set of voxels with the given grid step exists.



- Easy to validate.
- Not concise (verbose).
- **Efficient** in applications where objects are boxlike (architecture) or extremely irregular (biomedical).



# Contents

## 2. Schemes for representing solids

- Ambiguous schemes
- Pure primitive instancing
- Cell decompositions
- Spatial occupancy enumeration
- **Constructive Solid Geometry**
- Sweep representations
- Boundary representations
- Medial Axis Transforms



*"Still with Bolts"* by [Jaime Vives Piqueres](#) (2002)



# Constructive Solid Geometry (CSG)

---

- CSG is based on a set of 3D solid primitives and **regularized set-theoretic operations**
- Traditional primitives: block, cylinder, cone, sphere, torus
- Operations; union, intersection, difference + translation and rotation



# Constructive Solid Geometry (CSG)

## CSG tree

- A complex solid is represented with a binary tree usually called **CSG tree**

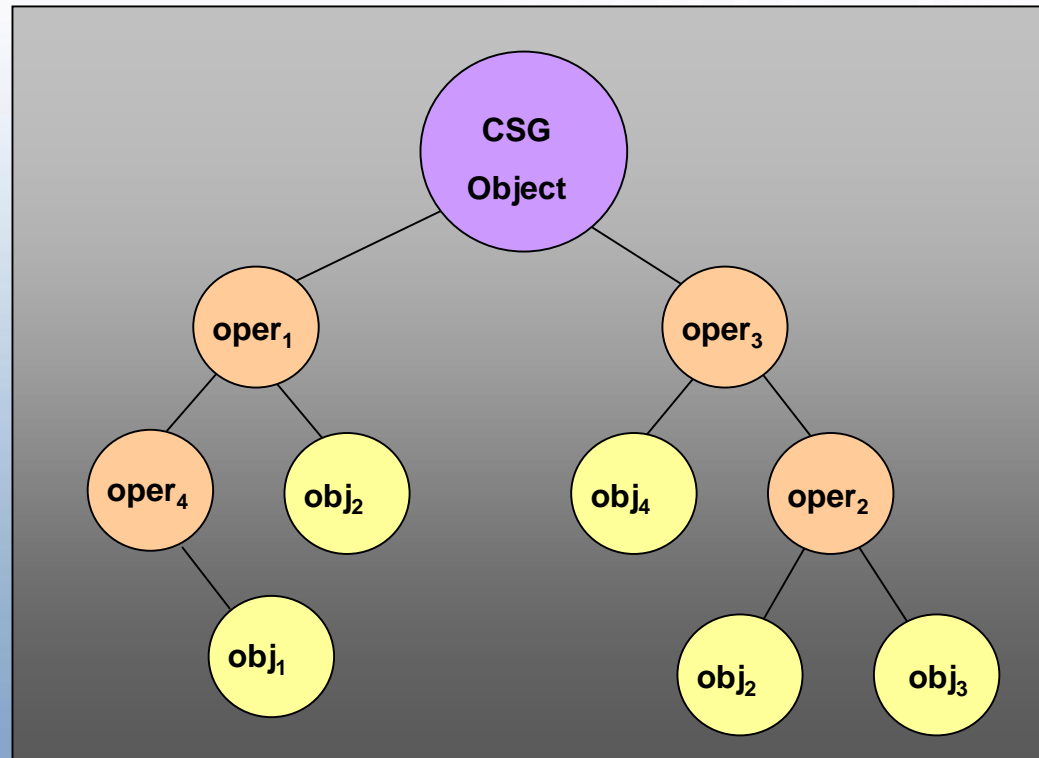



## Properties

- **Domain** depends on the set of primitives and on the set of operations.

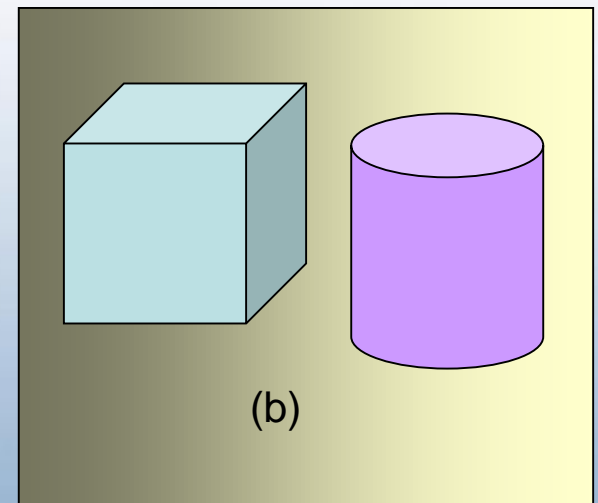
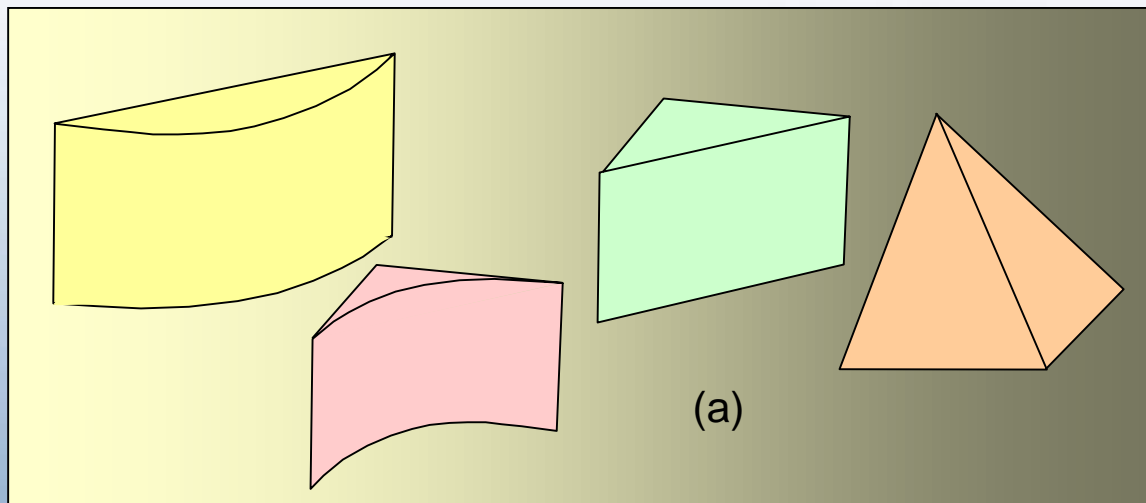

Two CSG schemes having different primitives but the same domain.

# Properties

- **Unambiguous**

A CSG tree defines one solid.

- **Nonunique**

There are several possible CSG trees for one solid.

- **Validity**

Any syntactically correct CSG tree is **valid**, if the primitives are r-sets.

- CSG tree based on unbounded primitives may represent bounded sets and therefore be invalid.



- **Concise**  
if primitives are well matched to the domain
- Humans can **easily create** CSG representations
- **Efficient**  
for rendering and computing integral properties; not efficient for line drawings and certain types of graphic interactions (“pick an edge”).





# Sweep representation

- A set of all points visited by an object  $A$  moving along a trajectory  $B$  is a new solid, called a **sweep**.
- **Translational sweeping (extrusion)**: 2D area moves along a line normal to the plane of the area.

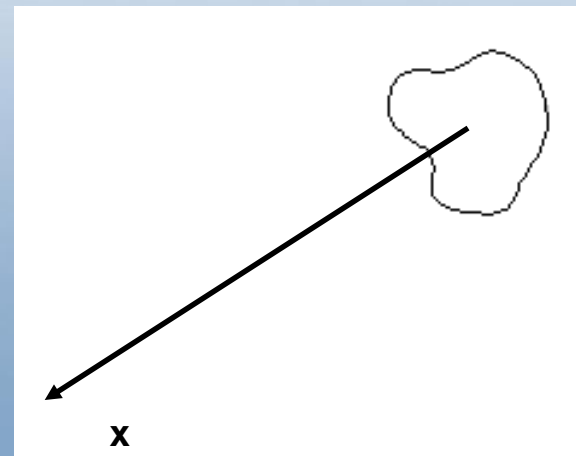
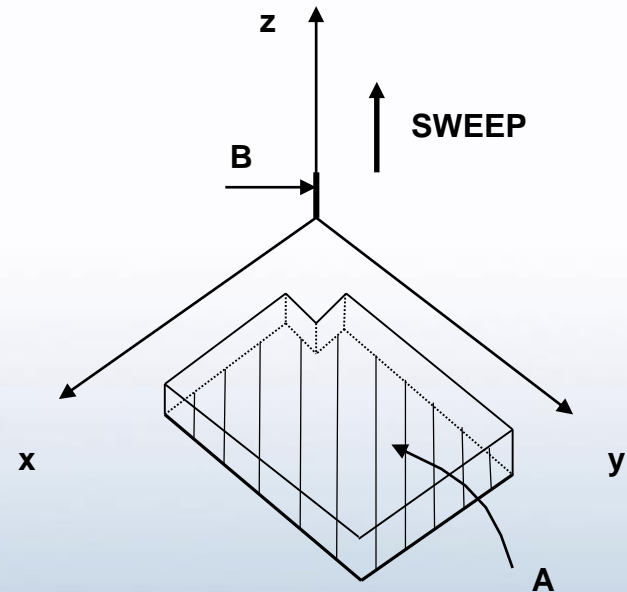



- **Rotational sweeping** is defined by rotating an area about an axis

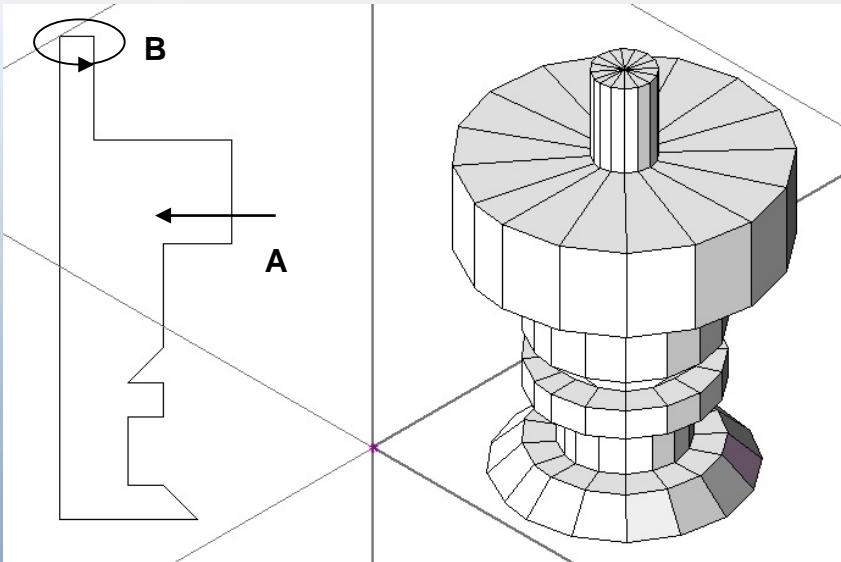

[www.tipus.uniroma3.it](http://www.tipus.uniroma3.it)

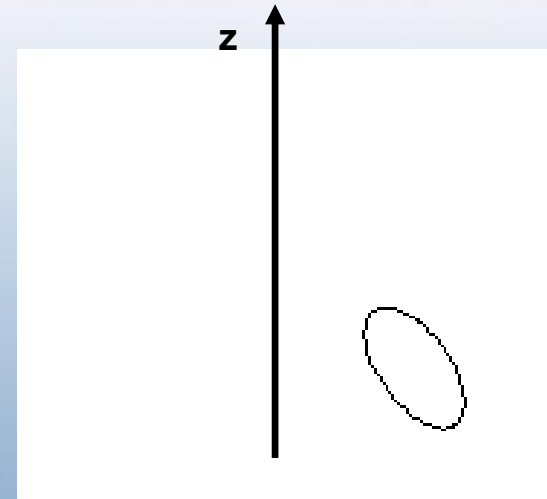

Image by Martin Culpepper, 1999



- Sweeps with a generating area changing in size, shape or orientation and following an arbitrary curved trajectory are called **generalized cylinders**.

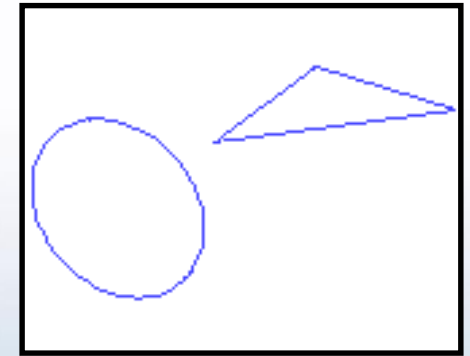

Image by Martin Culpepper

Problems: sweeping by moving solid, self-intersections, CSG operations on sweep.



# Properties

- Unambiguous

A moving object + a trajectory define one solid

- Not unique

- General **validity** conditions for sweep representations are unknown. General sweeping may produce non-regular sets.

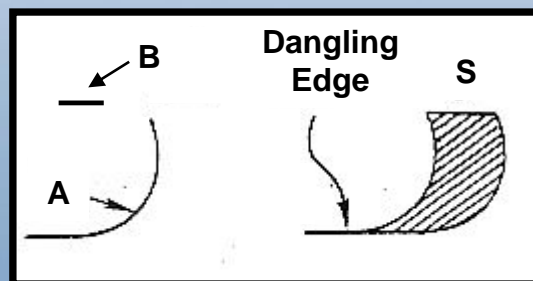



- 
- **Applications of sweeping** by a moving solid: material removal (NC machining), dynamic interference of solids.
  - **Sweeping by a moving solid**: lack of known algorithms for computing properties.



# Boundary representation

Example: A boundary representation for a cube

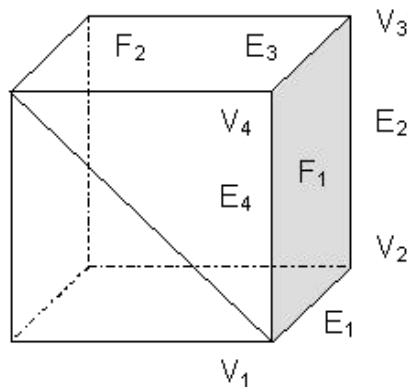
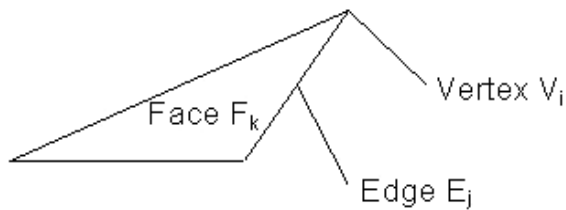

*Topological structure*

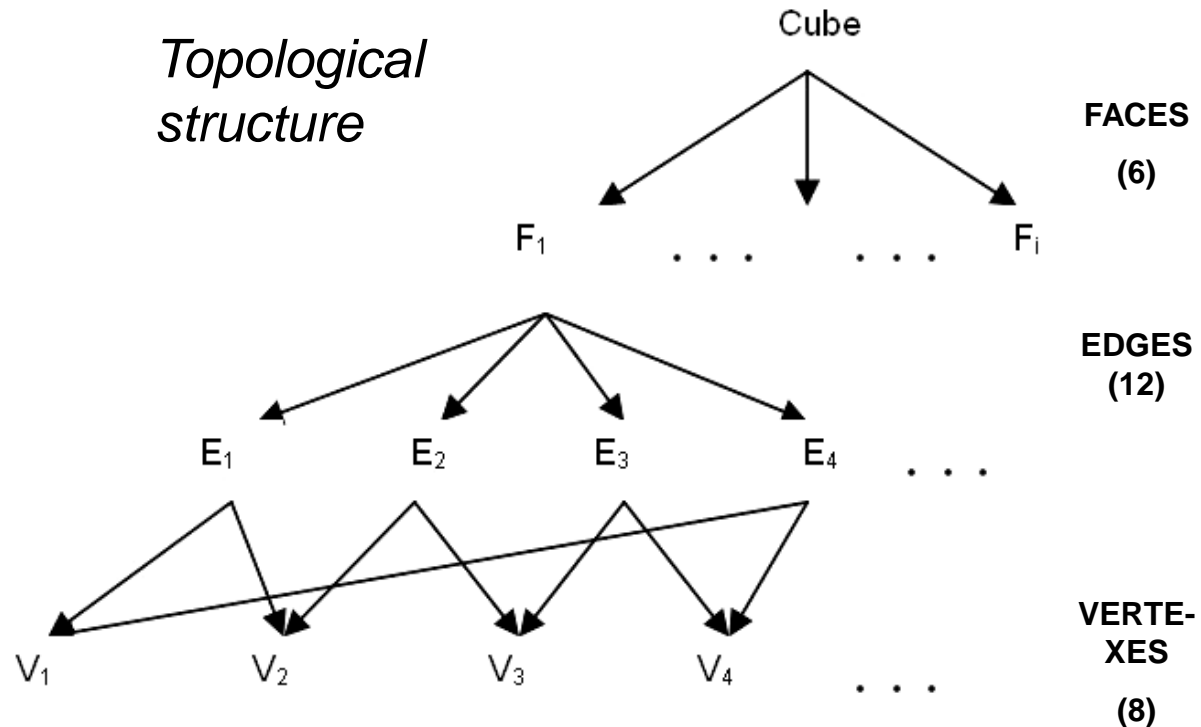



# Properties

---

- **Domains**

are as reach as those of cell-decomposition or CSG schemes. Given a CSG scheme it is always possible to design BRep scheme with the same domain.

- **Unambiguous**

if faces are represented unambiguously.



- Not unique

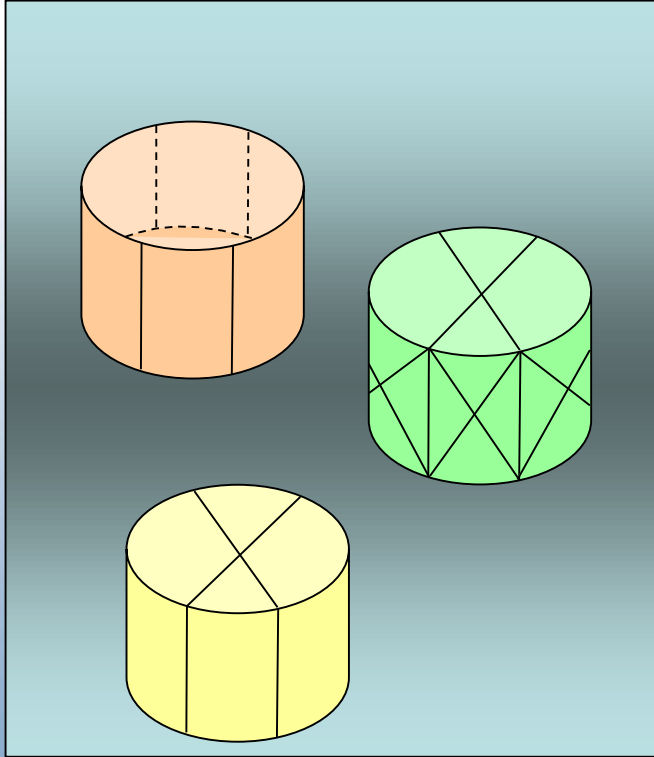
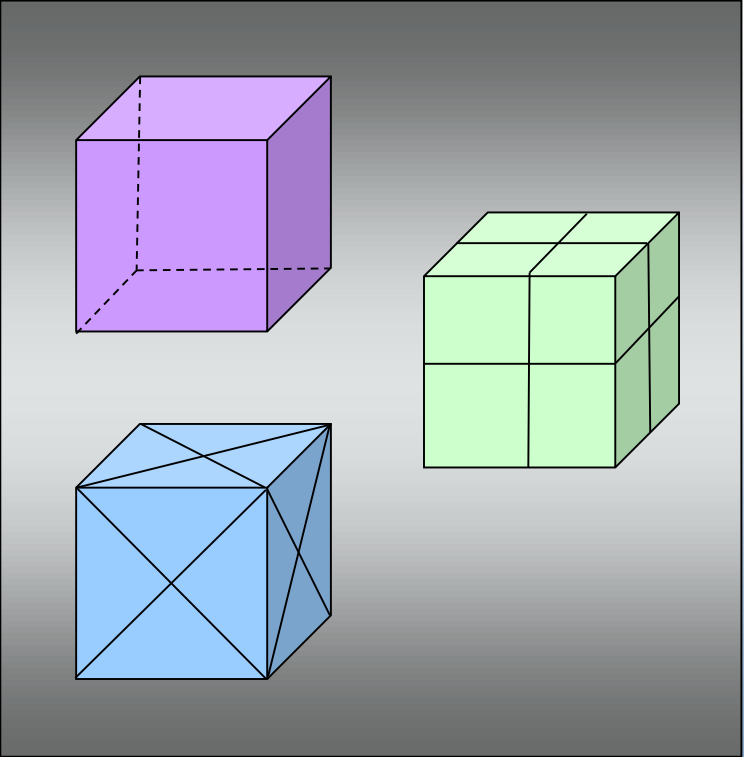





- **Validity**  
control requires expensive calculations.
- **Not concise** (verbose)  
More than 10 times longer than corresponding CSG.
- **Difficult**  
for humans to construct.
- **Efficient**  
in line and shaded drawings, graphic interaction and topological applications.

# ARISTIDES A. G. REQUICHA *Representations for Rigid Solids*

## SUMMARY OF REPRESENTATION SCHEME PROPERTIES AND APPLICABILITY

Schemes		PROPERTIES					APPLICATIONS											
		DOMAIN	VALIDITY	COMPLETENESS	UNIQUENESS	CONCISENESS	EASE OF CREATION	NULL OBJECT	OBJECT EQUALITY	LINE DRAWINGS	GRAPHIC INTERACTION	SHADED DRAWINGS	MASS PROPERTIES	HOMOLOGICAL PROPERTIES	FINITE ELEMENT ANALYSIS	INTERFERENCE ANALYSIS	ROUGH MACHINING	FINISH MACHINING
PRIMITIVE INSTANCING			G	G	G	G	G	G	G		?	G	G	?		G	G	G
SPATIAL ENUMERATION			G	G	G			G	G	?	?	?	G	G	G			
CELL DECOMPOSITION		G		G				G		?	?	?	P	G	P	?	?	?
CSG	GENERAL 1/2 SPACES	G		G				?	?		P	?	?		P	P	?	P
	BOUNDED PRIMITIVES	G	G	G		G	G	?	?		P	?	?		P	P	?	P
SWEEP	TRANSLATIONAL & ROTATIONAL		G	G	?	G	G	G	?	G	G	?	G	?	P			
	GENERAL	G		G				G										
BOUNDARY		G		G	?			G	?	G	G	P	?	P			P	

KEY:    G = GOOD    P = PROMISING    ? = UNCLEAR    BLANK= UNPROMISING OR POOR

PARADIGM	FAMILY NAME	VARIANT	MATHEMATICAL MECHANISM	ACCESSIBLE ATTRIBUTES	SPECIAL PROPERTIES
Instantiation	Templates <sup>1</sup>		Special-Case Formulae		
Cell Composition (Gluing)	Spatial Enumeration <sup>2</sup>	Linear subdivision of space $\Rightarrow$ rectilinear grids of equal-size cells	Union of Quasi-Disjoint Solid Cells $Solid = \cup C_i$ where $C_i \cap_n C_j = \emptyset, i \neq j$	Interior, Discretized into Cells	Spatial Addressability
		Recursive subdivision $\Rightarrow$ hierarchically graded cells (quadrees, octrees)			
	Cell Decomposition	Simplicial or Cell Complexes; elements produced by object partitioning (e.g. triangulation)			
	Boundary Representations (B-reps)	Exact boundaries	Union of Boundary Cells $\partial Solid = \cup Face_i$ $\partial Face = \cup Edge_j$ (Solids thru boundary determinism)	Boundary, Surface 'Features'	
Linear approximations ('tilings', 'facets')					
Boolean Composition	Constructive Solid Geometry (CSG)	Halfspace primitives	Regularized boolean composition	Solid primitives, syntactic structure	Recursive partitioning
		Bounded solid primitives			
Generation	Sweep Representations	Simple sweeps: S constant, M a single rotation or translation	'Infinite Union': Sweep(S, M(t)) = $\cup S(t_i) @ M(t_i), \forall t_i \in [interval]$	Generator Elements (S, M)	(Limited domains)
		General sweeps			
	Medial Axis Transforms (MATs) <sup>3</sup>		$\cup Spine(p) \oplus Sphere(R(p))$	Spine (skeleton); Radius function	
Spatial Sampling	Ray Representations <sup>3</sup>		Induced cell decompositions	Ray-sampled inferior	Directional sampling
	Parametric Sample Sets <sup>3</sup>		Interpolation	Sampled boundary	
Real and Vector Functions	Parametric-function Representations <sup>3</sup>		Homeomorphic mapping over finite domains	Interior	(Limited domains)
	Real-function Representations <sup>3</sup>	Differentiable Indicator Functions	$f(p) > 0 \Rightarrow p \in iS$ $f(p) = 0 \Rightarrow p \in _S$ $f(p) < 0 \Rightarrow p \in cS$	Point classifications	Boolean composition through arithmetic operations

<sup>1</sup> Called 'Pure Primitive Instanting' in Requicha's paper in *ACM Computing Surveys*, December 1980.

<sup>2</sup> Called 'Spatial Occupancy Enumeration', without linear and hierarchical distinctions, in Requicha's 1980 paper.

<sup>3</sup> Not acknowledged in Requicha's 1980 paper.



# Medial axis representations

The **medial axis** of a 2D object is defined as the closure of the locus of centers of maximal inscribed disks. A disk is maximal if no other disk contains it.

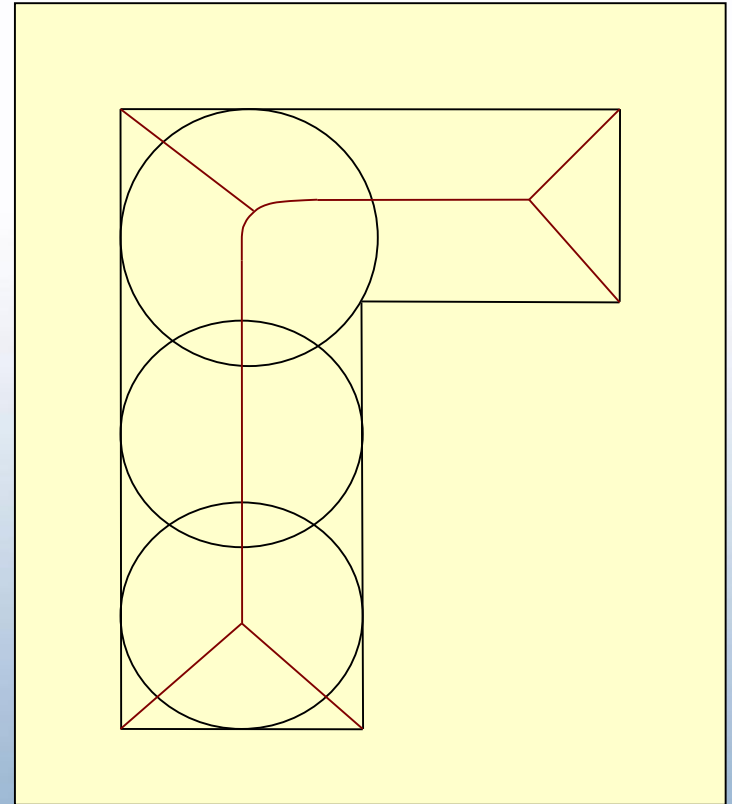

Hoffmann "Solid modelling" Overview

L-shaped domain and associated medial axis. Some maximal inscribed circles contributing to the medial axes are also shown.



# Medial axis representations

The **medial surface** of a 3D solid is the closure of the locus of centers of maximal inscribed spheres.

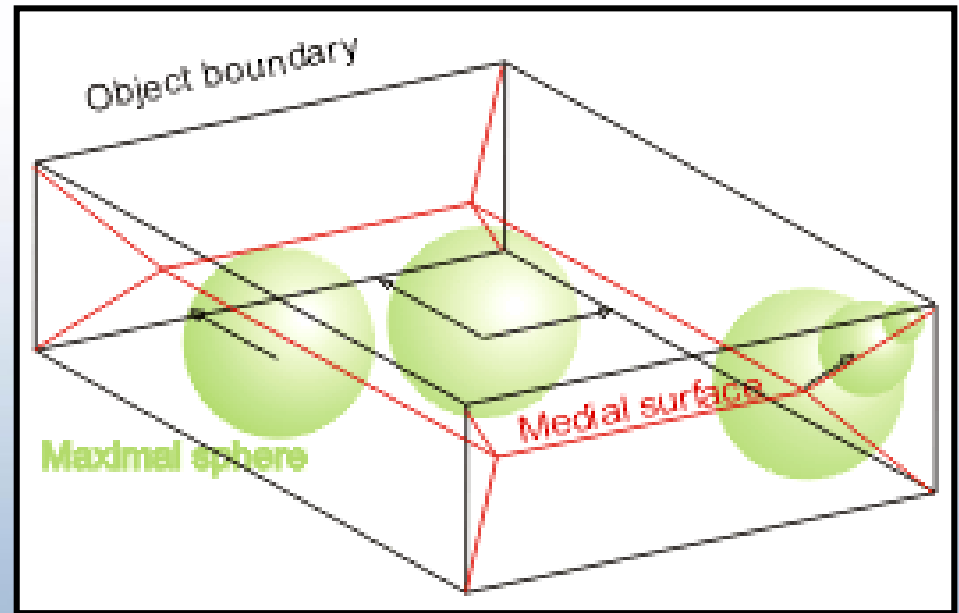

# Morphology of 3D skeleton



- (a) super-ellipsoidal block;
- (b) skeleton of block with various element labeled;
- (c) exploded skeleton showing separated patches.

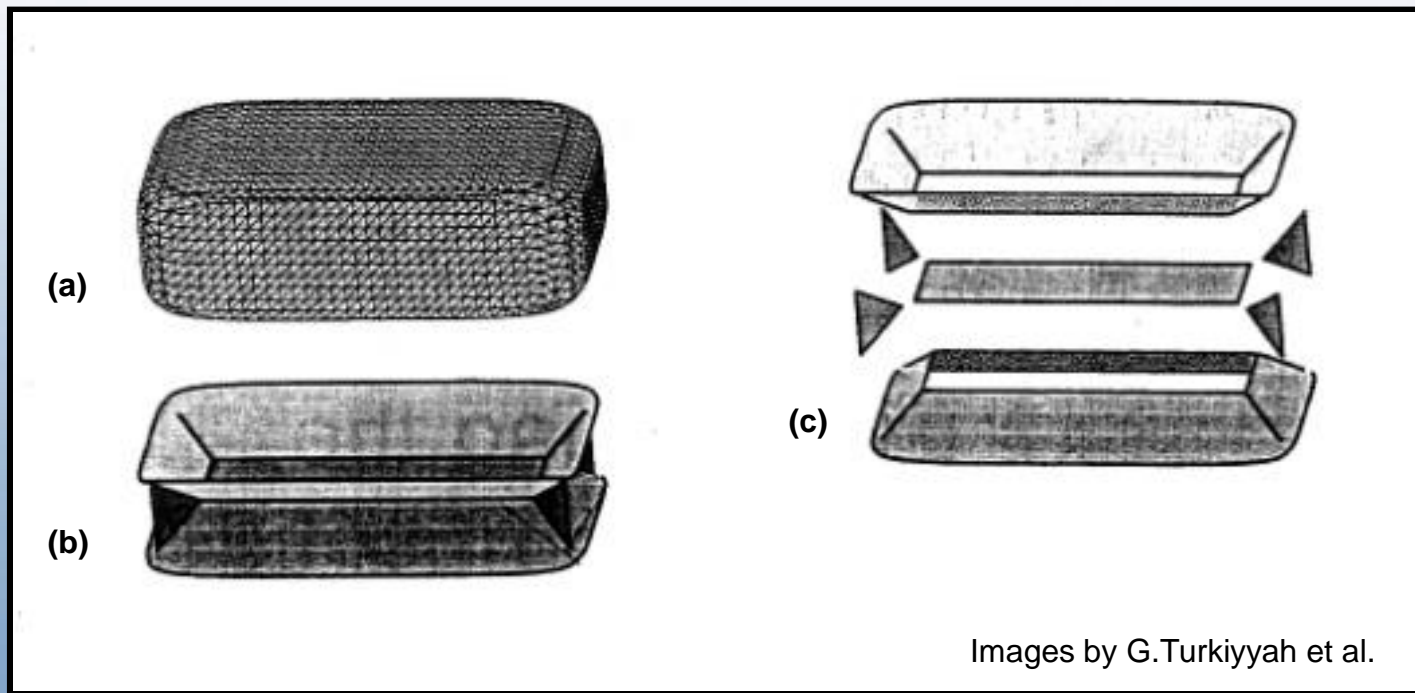



# Medial axis representations

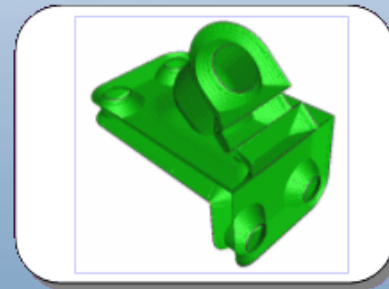
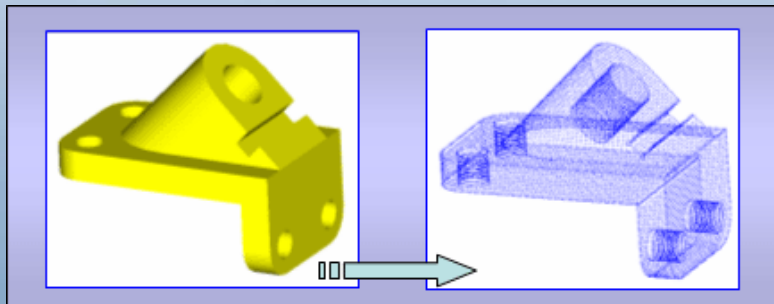
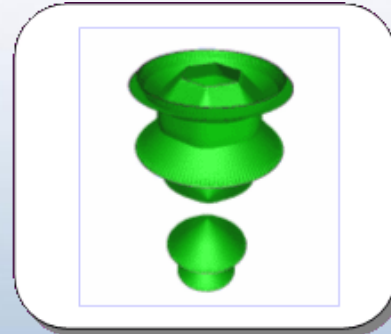
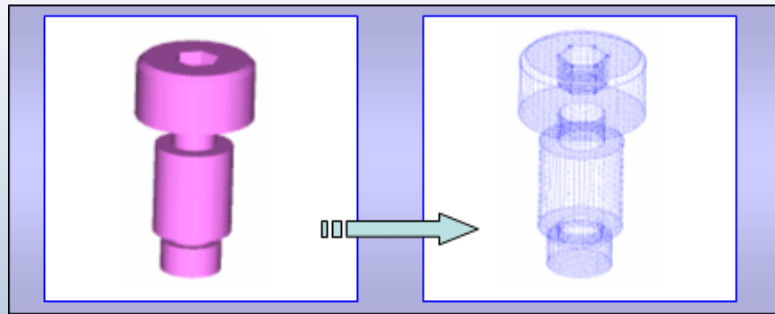
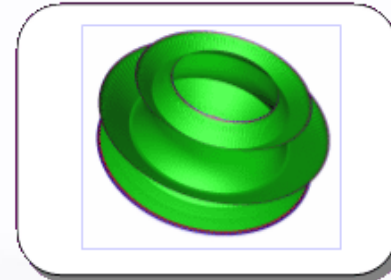
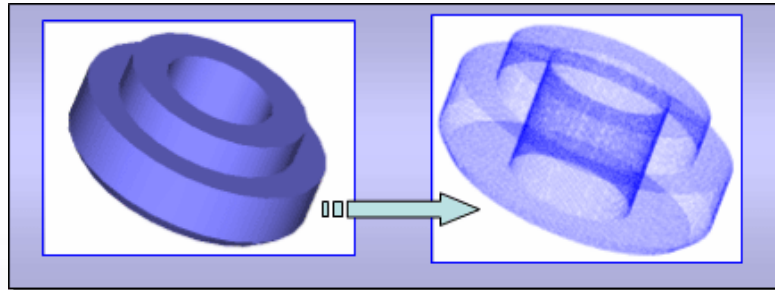

Properties:

- Unambiguous
- Unique
- Efficient in meshing algorithms



# Contents

- **Ray representations**
- Parametric function representations
- Real function representations
- Hybrid schemes and conversions

3. Solid modelling systems

4. References

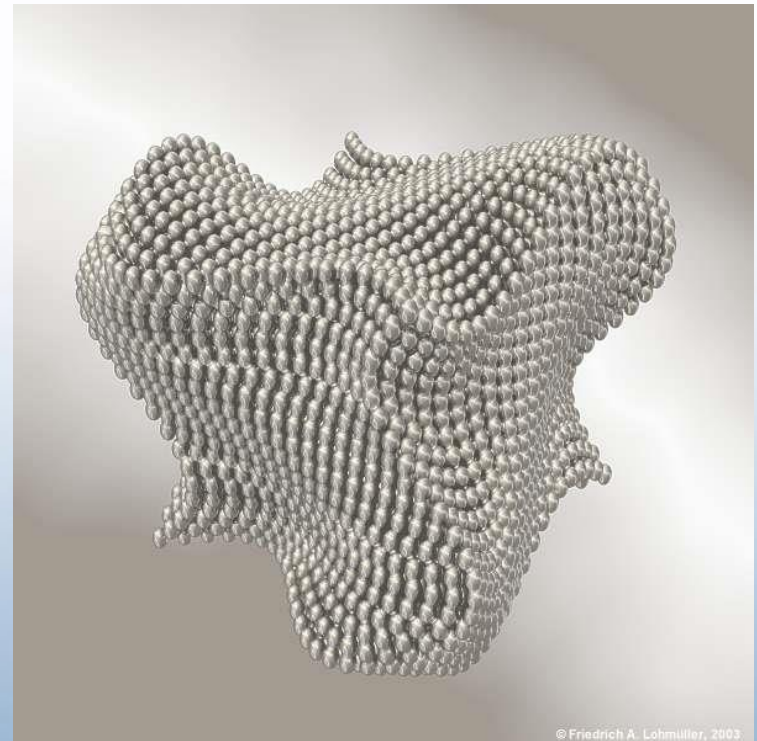

*"Dancing Cube"* by [Friedrich A. Lohmueller](#) (2003)





# Ray representations

A **ray grid** is a finite set of regularly spaced parallel lines with an associated direction  $V$ .

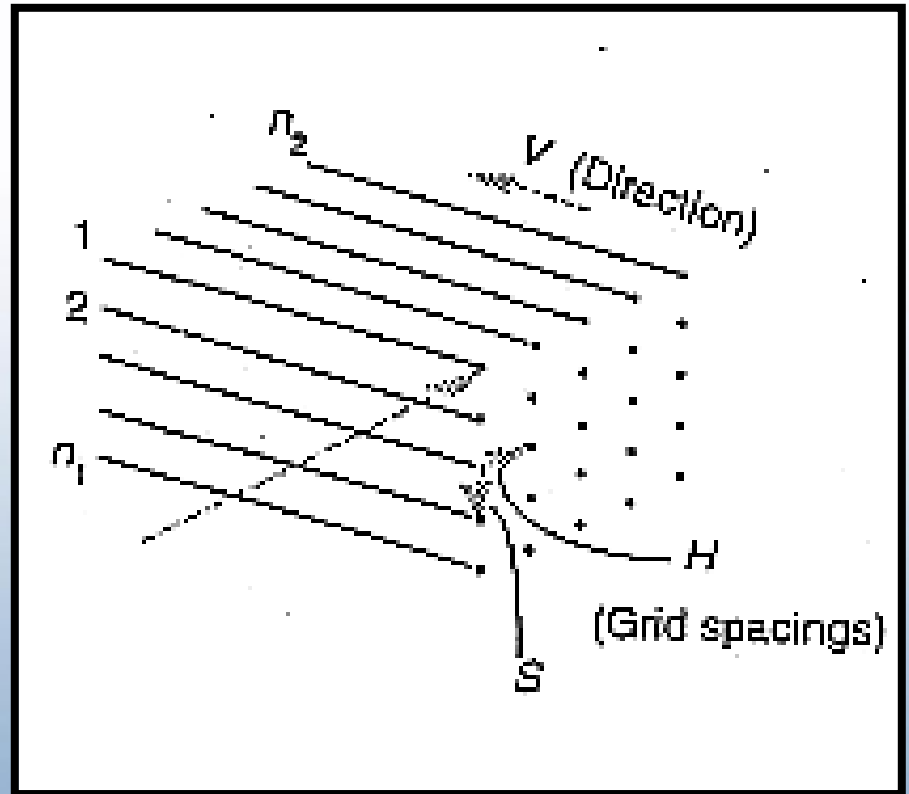



## Ray representations

A **ray representation** of a solid is a set of segments resulting from the intersection of the ray grid with the solid.

A ray-rep might also contain **tags**,

descriptive symbolic information appended to the segments. Tags can identify the primitive half-spaces in solid's CSG or faces in its B-rep.

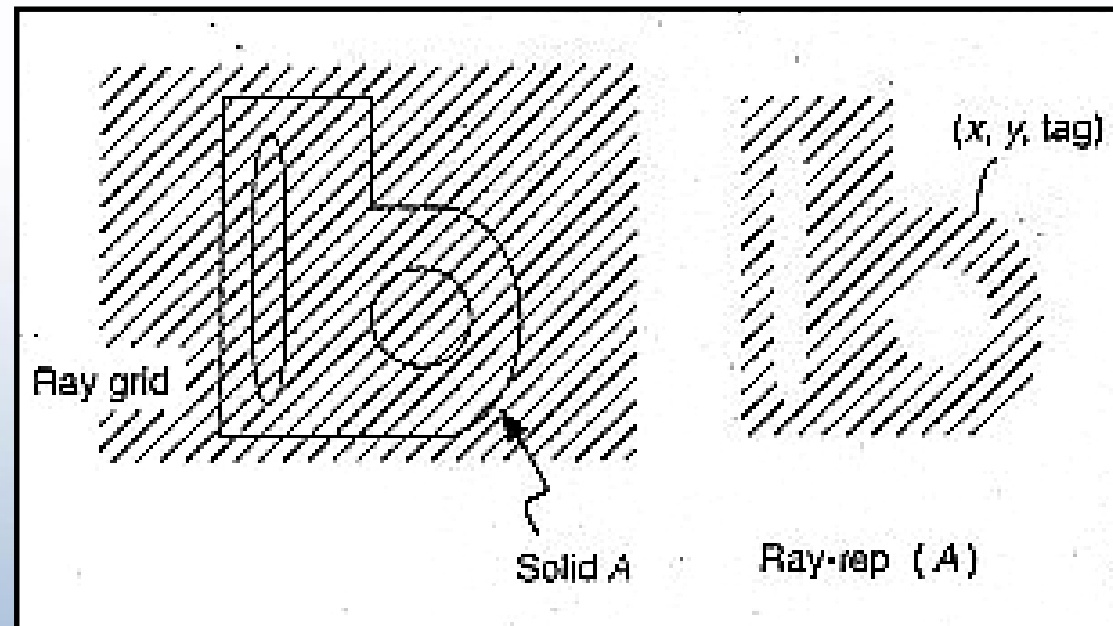



## Properties:

- **Unambiguous**  
under suitable conditions and with appropriate tags. Can be converted exactly from and to CSG and B-rep
- **Not unique**  
Depends on grid spacing



# Parametric function representations

Shapes are represented by multidimensional, continuous, piecewise-differentiable **parametric functions**:

$$F: \mathbb{R}^n \rightarrow \mathbb{R}^m$$

where  $\mathbb{R}^n$  is parameter space and  $\mathbb{R}^m$  is object space.

For  $n=2$ ,  $m=3$

$$[x(u,v), y(u,v), z(u,v)]$$

defines a surface in 3D space.

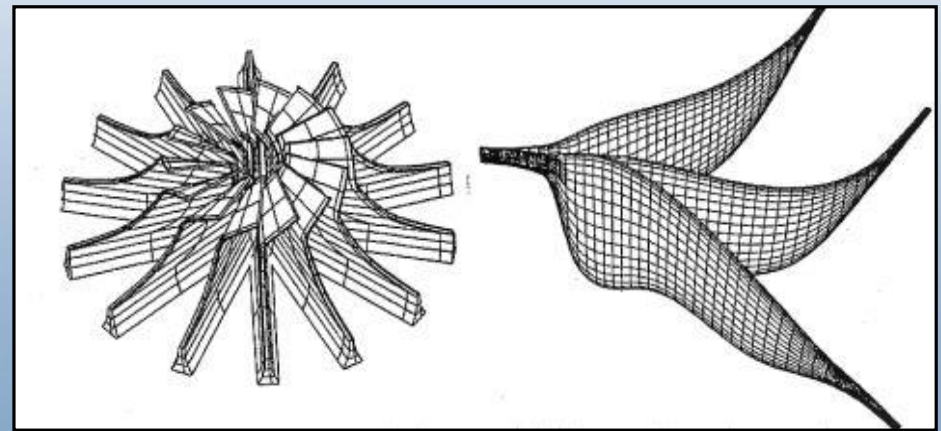



# Properties

---

- Extension and generalization of sweeping
- Unambiguous, non unique representation
- Compact and easy to create
- Efficient algorithms  
with the use of interval analysis



# *Real function representations*

*An object is defined by  
a single continuous  
real function of several  
variables:*

$$f(x_1, x_2, \dots, x_n) \geq 0$$

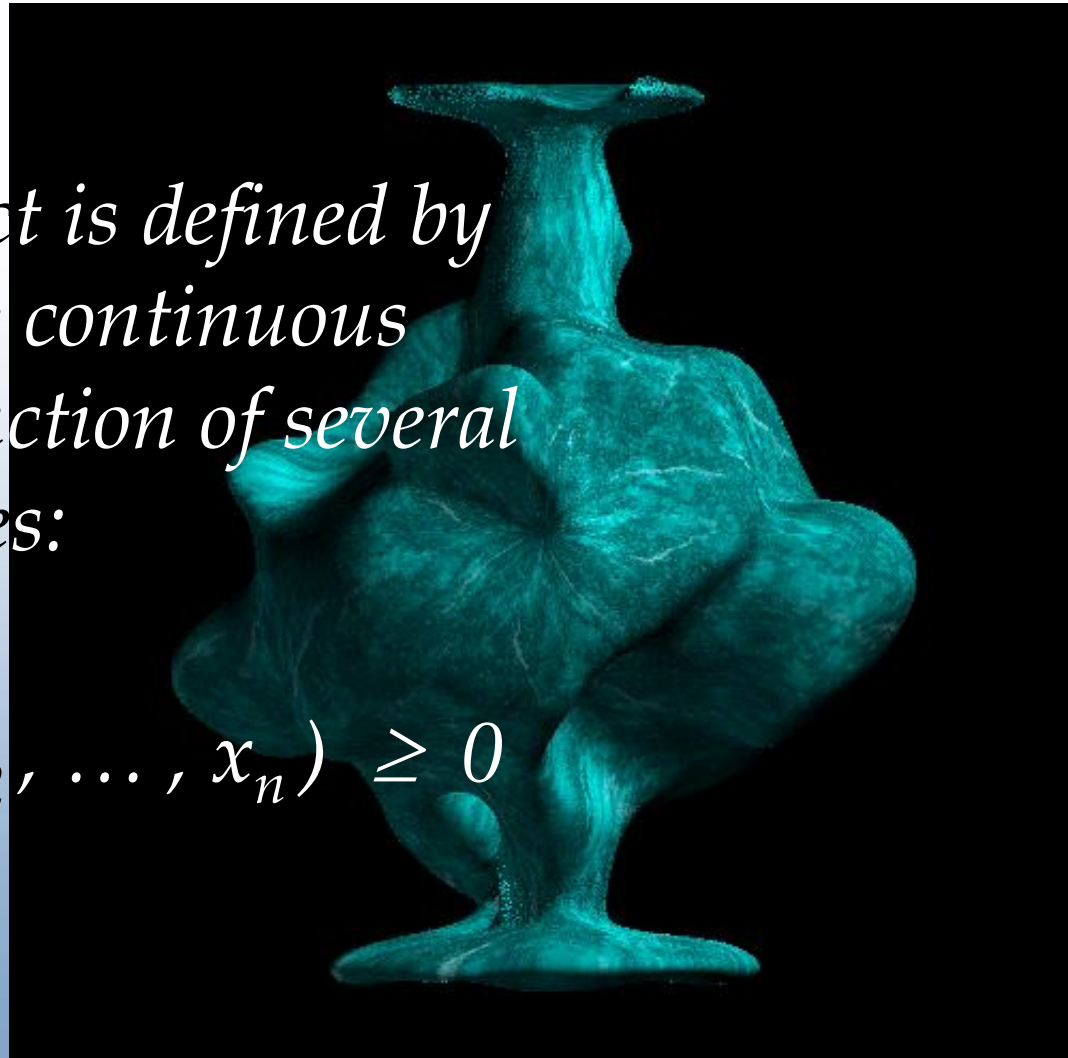



- A function  $f$  can be defined analytically, with an evaluation algorithm, or with sampled values and an appropriate interpolation procedure.





# Function representation FRep

---

- Uniform representation of multidimensional objects defined as

$$F(X) \geq 0$$

- Function  $F(X)$  evaluation procedure traversing the construction tree structure
- Leaves: primitives
- Nodes: operations + relations
- System extensibility





# Construction of metamorphosis

FRep

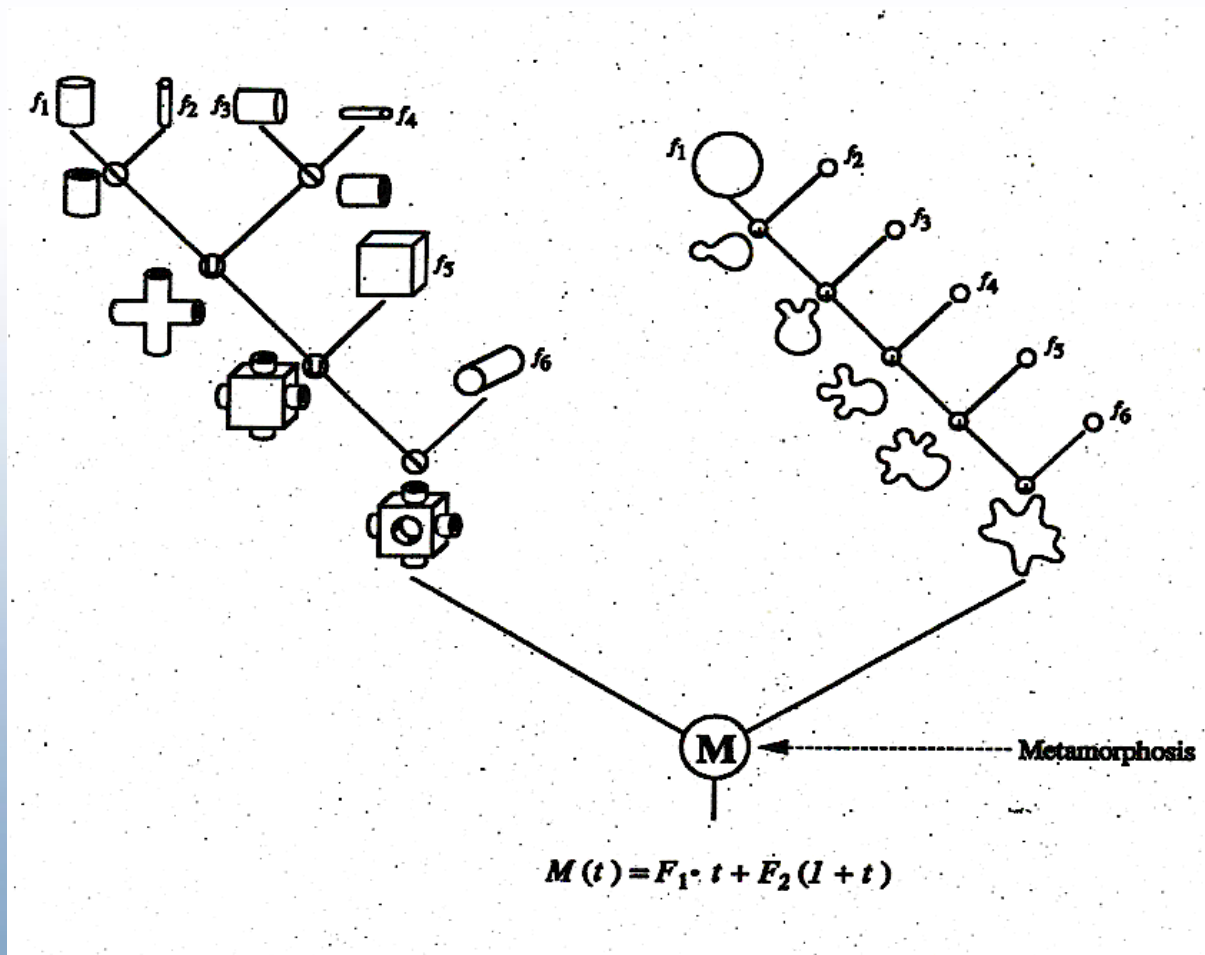



# Properties

---

- Closed under the arithmetic, set-theoretic, Cartesian product, projection and other operations.
- The abstraction level is higher than that of other known representations.

Combinations of the following modelling styles are supported: CSG, sweeping, implicit and volumetric objects.

# Real function representations

## Properties



- Unambiguous

A function defines one object

- Not unique

for example,  $k \cdot f \geq 0$

- Concise and easy to create

- Efficient

in modelling highly complex objects



# Contents

- Ray representations
- Parametric function representations
- Real function representations
- **Hybrid schemes and conversions**

3. Solid modelling systems

4. References

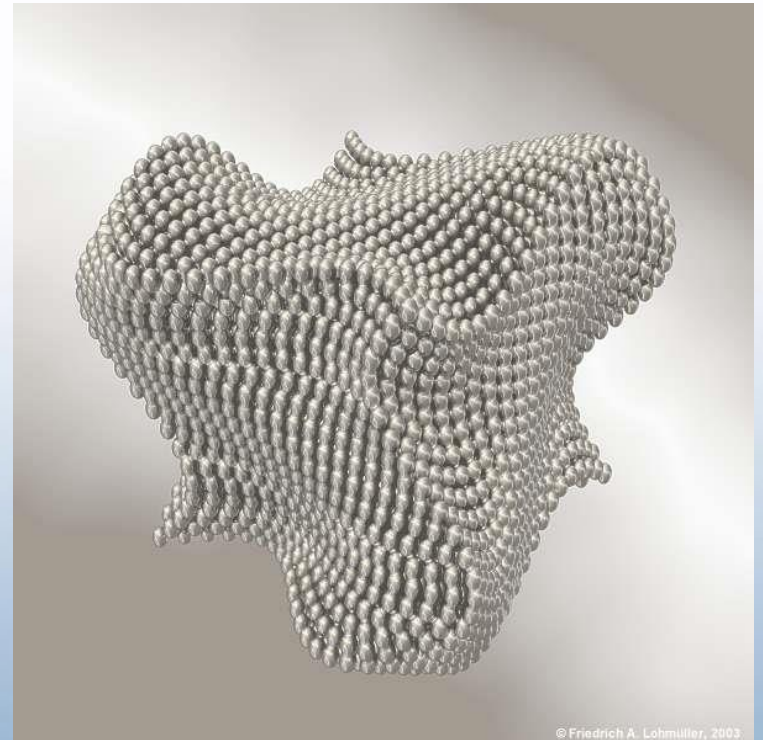

*"Dancing Cube"* by [Friedrich A. Lohmueller](#) (2003)



# Hybrid schemes and conversions

---

- **Hybrid, or non-homogeneous,** representation schemes may be designed by combining several schemes:
- 1) CSG/ boundary hybrid: CSG-like trees whose leaves are primitive solids or B-rep non-primitive solids.

Is used as the basis for the input language of some systems.



- 2) CSG/sweep hybrid: CSG-like trees whose leaves may be solid-sweep representations. Useful in numerically controlled (NC) machining and computer vision.

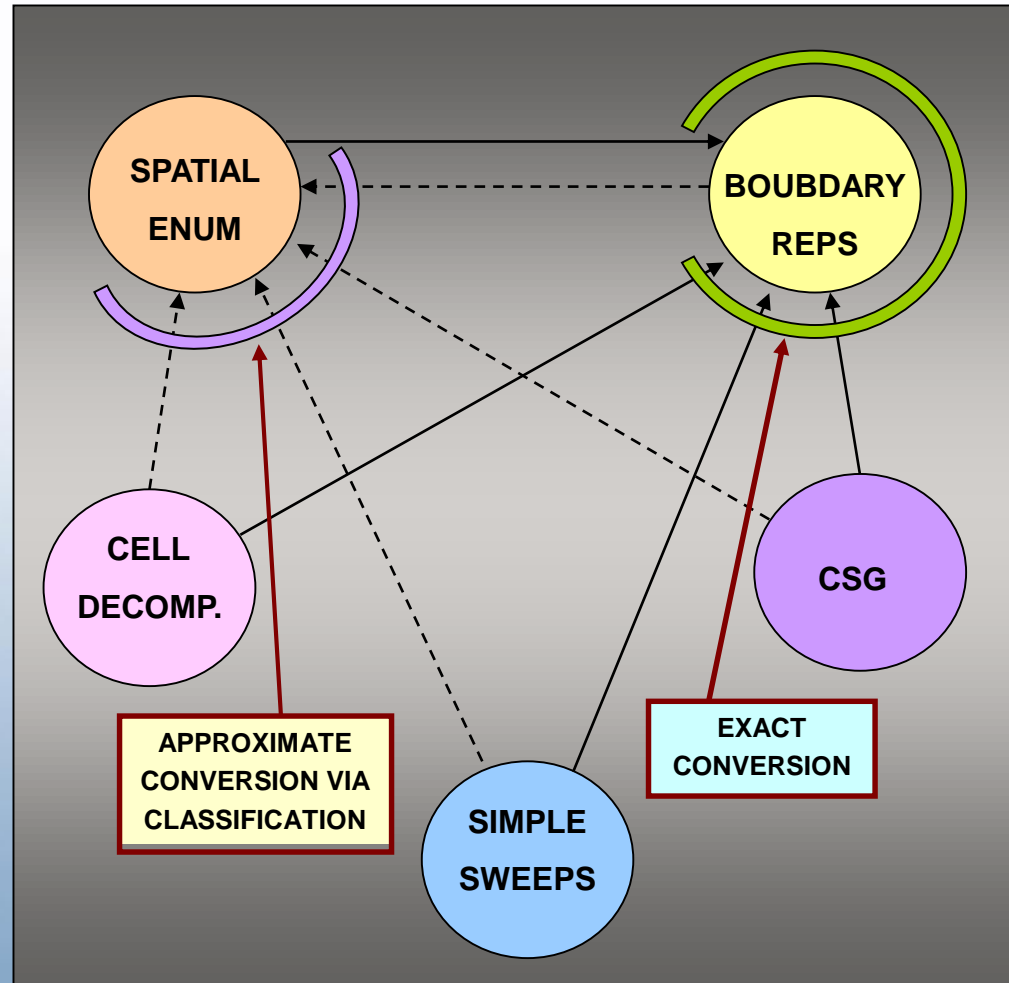



- Reasons for the lack of bidirectional exact conversions:
  - 1) schemes such as sweeps have smaller domain than CSG, B-rep, or cell decompositions;
  - 2) algorithms are not known.
- Exact conversion from CSG to B-rep (“*boundary evaluation*”) requires nontrivial algorithms.



# Architectures of solid modelling systems

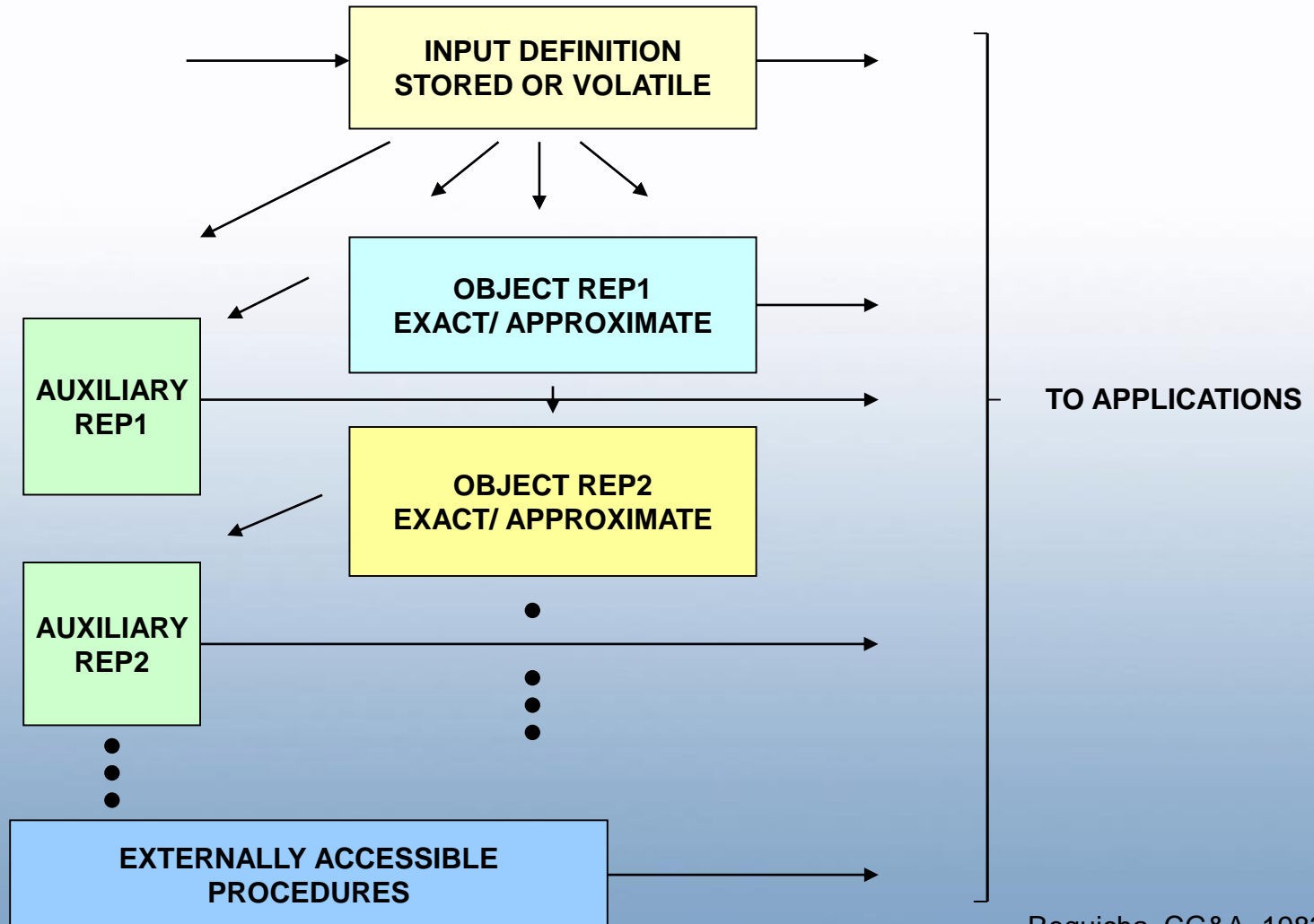





- A **solid modelling system** is regarded as
- 1) a specific collection of representations (exact, approximate, auxiliary) with at least one being valid and complete;
- 2) a collection of procedures for managing representations, conversions, and other geometrical calculations.
- **Applications:** graphics, mass properties calculations, finite-element meshing, interference checking and path planning, mechanism simulation, rapid prototyping, manufacturing, data storage and exchange.



# Single representation and hybrid systems

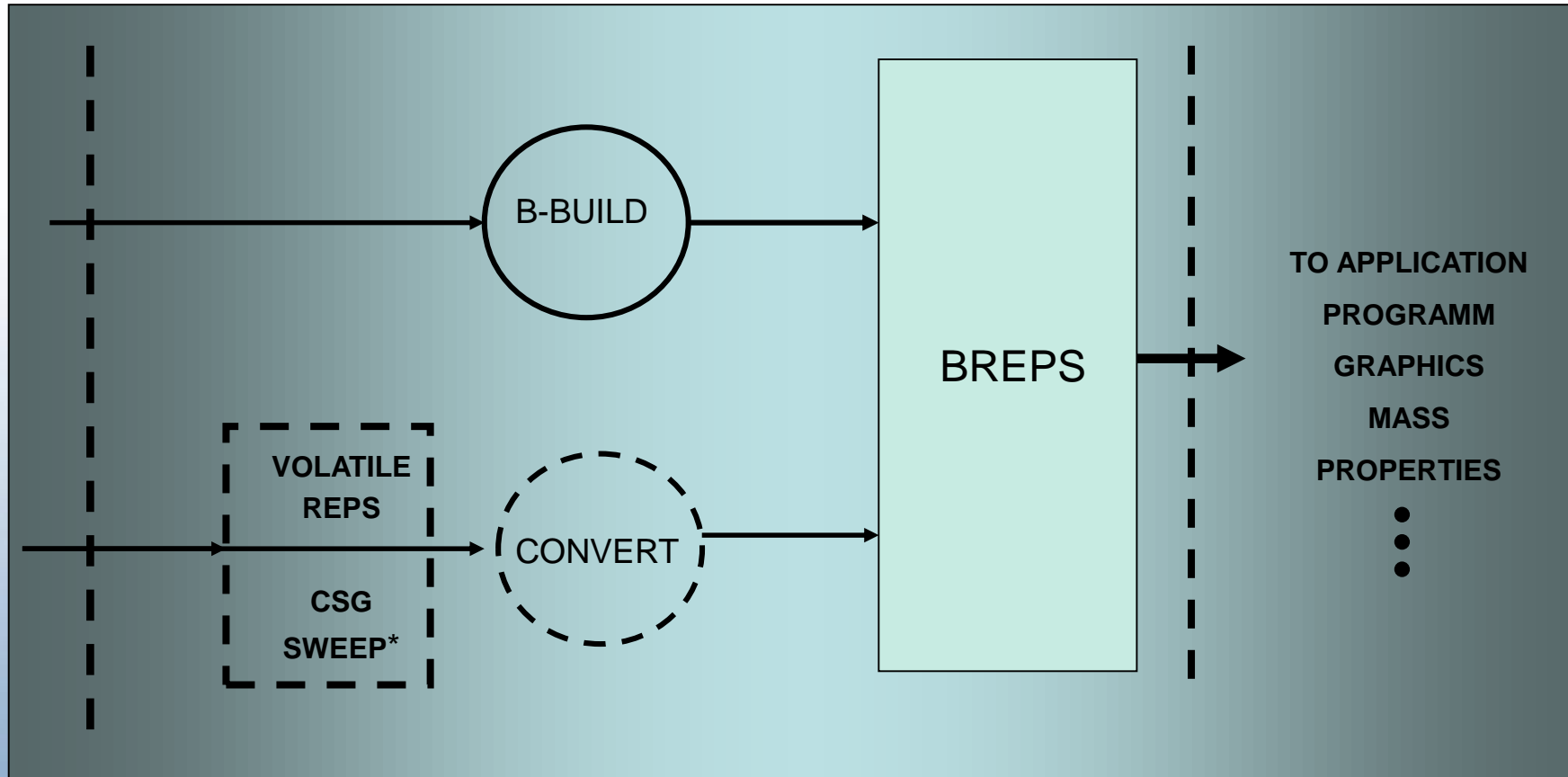

Single (boundary) representation systems



# Single representation and hybrid systems

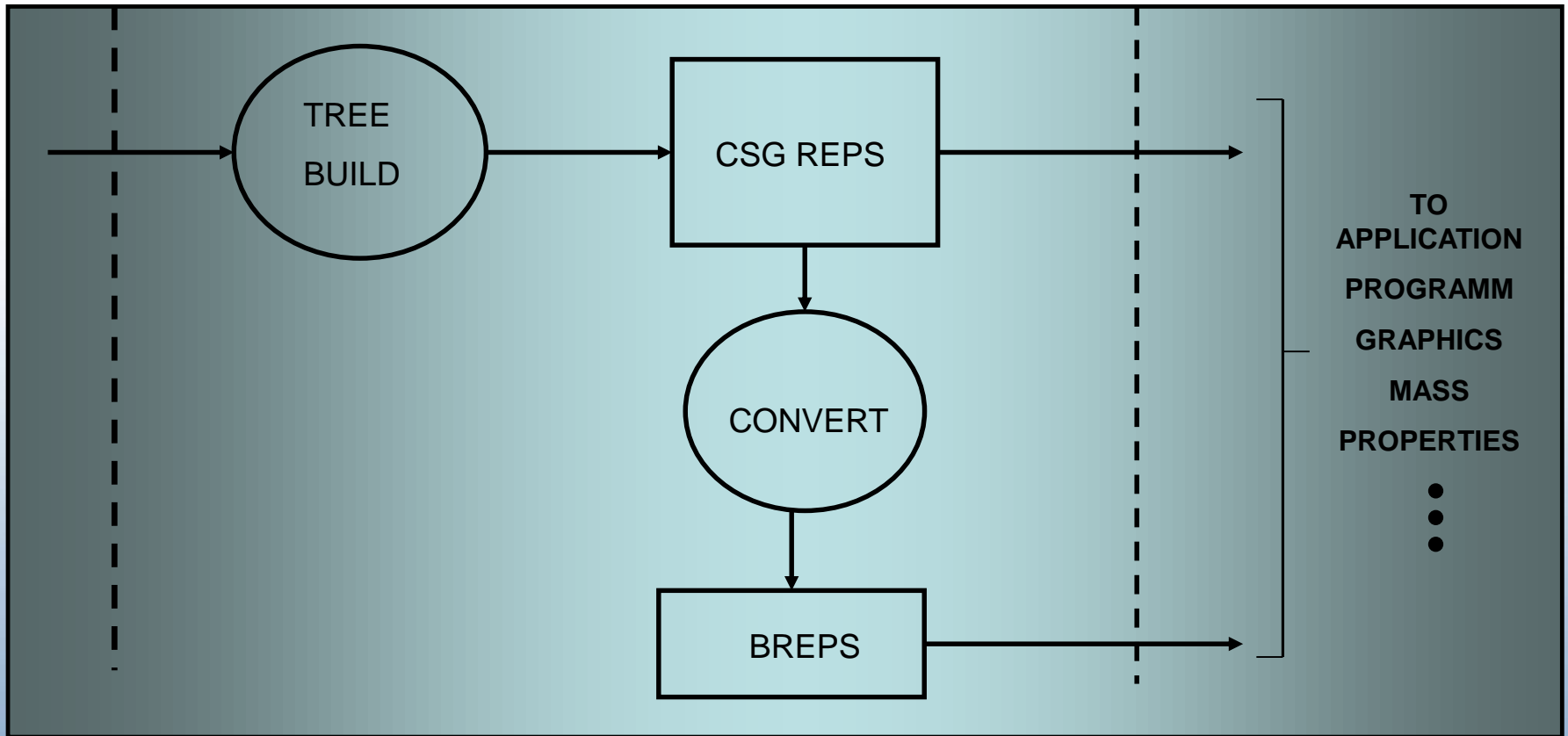

Hybrid CSG/ BRep systems

## Representational facilities of selected geometric modeling systems.

SYSTEM	PRIMARY REP SCHEME	DOMAIN (DEFINED BY HALFSPACES)	OTHER CONSISTENT REPS	INPUT BASED ON	INPUT MODALITIES
SHAPES	CSG:	QUAD	—	CSG	SC;T/I;IG*
TIPS	HALFSPACES	"ARBITRARY"	—	CSG	T/B
GDP/GRIN	} CSG: BOUNDED PRIMITIVES	QUAD	≈ B-REP	CSG	SC;IG
PADL-1		PL & CYL (⊥)	B-REP	CSG	T/I
PADL-2		QUAD	B-REP	CSG	SC;T/I
SYNTHAVISION		QUAD, SS	WIREFRAME	CSG	T/B
GMSOLID	HYBRID CSG/B-REP	QUAD	B-REP	CSG, SWEEP*	IG
U.M./BORKIN	B-REP	PL	—	CSG, SWEEP*	T/I;IG*
BUILD-2	B-REP	QUAD	—	CSG, EOP	SC;T/I
CADD	B-REP	QUAD, SS	—	SWEEP*	IG
COMPAC	B-REP	QUAD	—	CSG, SWEEP*	T/B?
DESIGN	B-REP	QUAD	—	CSG	IG
EUCLID	B-REP	≈ QUAD	—	CSG, SWEEP*	T/I;IG?
GLIDE	B-REP	PL	—	CSG, SWEEP*, EOP	SC;T/I
MEDUSA	B-REP	≈ QUAD, SS	—	CSG, SWEEP*	IG
PROREN-2	B-REP	QUAD	—	CSG, SWEEP*	T/I
ROMULUS	B-REP	QUAD	—	CSG, SWEEP*, EOP	SC;T/I

PL = PLANE  
 QUAD = QUADRIC SURFACES (NOTE 1)  
 SS = SCULPTURED SURFACES  
 ⊥ = ORTHOGONAL POSITIONING  
 ≈ = APPROXIMATE  
 SWEEP\* = TRANSLATIONAL AND/OR  
 ROTATIONAL SWEEP

EOP = EULER OPERATIONS  
 SC = SUBROUTINE CALL  
 T/I = TEXT/INTERACTIVE ORIENTATION  
 T/B = TEXT/BATCH ORIENTATION  
 IG = SOPHISTICATED INTERACTIVE GRAPHICS  
 IG\* = SIMPLE INTERACTIVE GRAPHICS



# More late and modern systems

## Kernel modelers

- **Parasolid** (EDS Unigraphics, Cambridge, UK)  
BRep solid modeler supporting free-form surfaces (development of Romulus)  
<http://www.eds.com/>
- **ACIS** (Spatial Technology, USA)  
B-rep object-oriented toolkit (development of BUILD)  
<http://www.spatial.com/>
- **Designbase** (Ricoh, Japan)  
B-rep solid modelling library with free-form surfaces  
[www.ricoh.co.jp/designbase/](http://www.ricoh.co.jp/designbase/)
- **SVLIS** (Information Geometers, UK)  
CSG object-oriented kernel modeller  
[http://www.bath.ac.uk/~ensab/G\\_mod/Svlis/svlis.html](http://www.bath.ac.uk/~ensab/G_mod/Svlis/svlis.html)



## B-rep modelers

- **CATIA (Dassault, France / IBM)**  
<http://www.catia.ibm.com/>
- **AutoCAD Release (Autodesk, USA)**  
**based on ACIS**  
<http://www.autodesk.com/>
- **SolidWorks (SolidWorks, USA)**  
**PC+Windows interactive system based on Parasolid**  
<http://www.solidworks.com/>



## CSG based hybrid systems

- **Ray Casting Engine RCE** (Duke/ Cornell Universities, USA) VLSI parallel special-purpose computer based on CSG/ ray-rep  
<http://www.cs.duke.edu/~kedem/RCE/RCE.html>
- **POVRay** CSG/B-rep hybrid modeller for photorealistic rendering  
<http://www.povray.org>
- **BRL-CAD** (USA Army) CSG/ BRep solid modelling system  
<http://www.brl-cad.org>



## FRep based systems

- **HyperFun** (Aizu-Hosei, Japan; Bournemouth, UK) special-purpose high-level language and tools  
<http://www.hyperfun.org>
- **Symvol for Rhino** (Uformia, Norway) FRep plug-in to Rhinoceros CAD system  
<http://uformia.com/products/symvol-for-rhino/>





# References

- James D. Foley, Andries van Dam, Steven K. Feiner, John F. Hughes, Computer Graphics: Principles and Practice (2nd Edition in C ), Addison-Wesley, Reading, MA, 1997.

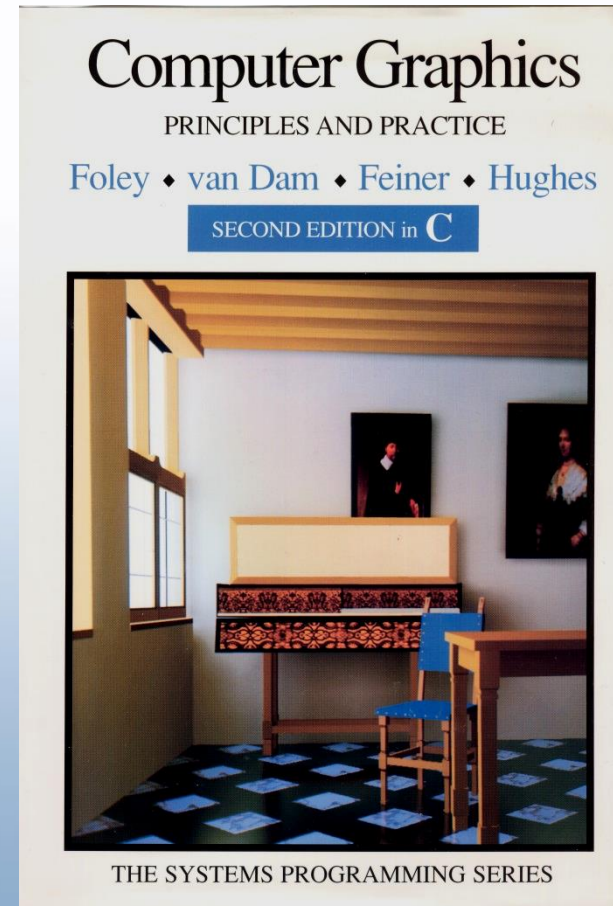



# References

- Aristides A. G. Requicha “Representations of rigid solids: theory, methods, and systems”, *computing Surveys*, vol. 12, No. 4, 1980, pp. 437-465.
- A. A. G. Requicha, H. B. Voelcker “Solid modelling: a historical summary and contemporary assessment”, *IEEE Computer Graphics and Applications*, vol.2, No.2, 1982, pp. 9-24.
- Michael E. Mortenson, *Geometric modelling*, John Wiley and Sons, 1985.  
Second edition, 1997.  
Third edition, 2006.

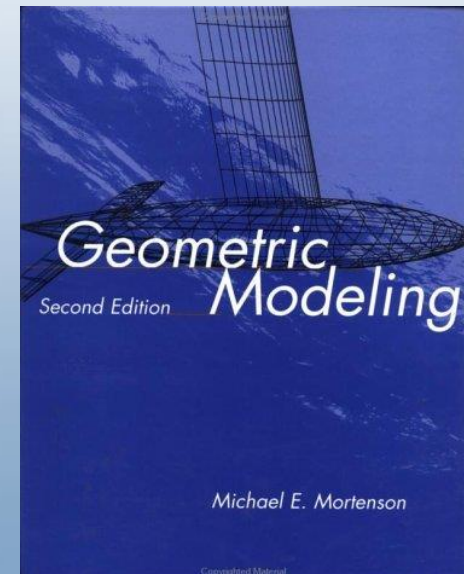



# References

---

- Christoph M. Hoffmann “Geometric and Solid modelling. An Introduction”, Morgan Kaufmann Publishers, 1989, 338 p.
- A.A.G. Requicha, J.R. Rossignac “Solid modelling and beyond”, IEEE Computer Graphics and Applications, vol.12, September, 1992, pp.31-44.
- Snyder, John M., Generative modelling for Computer Graphics and CAD: Symbolic Shape Design Using Interval Analysis, Academic Press, 1992.



# References

---

- Menon J., Marisa RJ, Zagajac J., More powerful solid modelling through ray representations, IEEE Computer Graphics and Applications, vol.14, No.3, 1994, pp.22-35.
- J. Rossignac. Through the cracks of the solid modelling milestone, From Geometric modelling to Advanced Visual Communications, S.Coquillart, W. Strasser, P. Stucki, Springer Verlag, pages 1-75, 1994.



# References

---

- Herbert Voelcker “Support for solid freeform fabrication”, NSF Workshop on Design Methodologies for Solid Freeform Fabrication, 1995.
- Christoph M. Hoffmann, Jarek Rossignac: A Road Map To Solid modelling, IEEE Trans. Vis. Computer Graphics, Vol.2, No.1, pp. 3-10,1996.
- A.A.G. Requicha “Geometric modelling: A First course”, 1999.
- Martin Culpepper, Understanding how things work, Lecture course, MIT,1999.



# Words of wisdom

*"...we are  
geometricians  
only by chance"*

*Dr. Johnson*

*"Without geometry,  
life is pointless"*

